



Diavia

FIAT DUCATO 2.2 MJT

(Serie X250) "101 HP" EURO4

CITROEN JUMPER 2.2 HDi

"101 -120 HP" EURO4

PEUGEOT BOXER 2.2 HDi

"101 -120 HP" EURO4

Codice/Code: 1FI34401E

Comando A.C. "ORIGINALE-DENSO"

Commande A.C. "ORIGINAL-DENSO"

A.C. Control "DENSO-ORIGINAL"

Klimaanlage "ORIGINAL-DENSO"

Mando A.C. "ORIGINAL-DENSO"

**Istruzioni montaggio
condizionatore d'aria**

**Instructions pour monter le
conditionneur d'air**

**Air conditioning
installation instructions**

**Klimaanlage
Einbauanleitungen**

**Instrucciones para el montaje
del equipo aire acondicionado**

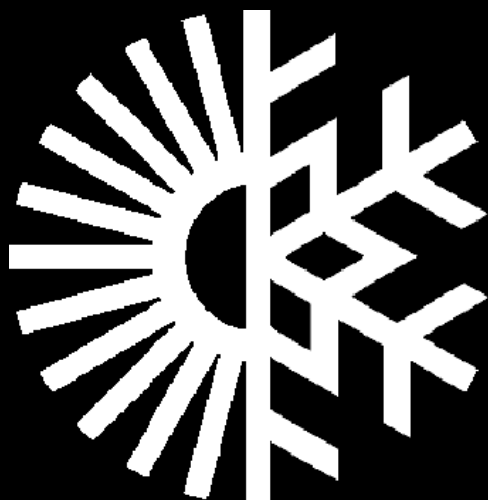

DELPHI ITALIA AUTOMOTIVE SYSTEMS S.r.l. "Stabilimento Molinella"

Via Nobili, 2 40062 Molinella (Bologna) - Italy

Telefono (0039) 051.6906111 - Fax (0039) 051.6906287 - Email: diavia.service@delphi.com

**DESCRIZIONE SIMBOLOGIA UTILIZZATA / DESCRIPTION DE LA SYMBOLOGIE UTILISÉE
DESCRIPTION OF SYMBOLS USED / BESCHREIBUNG DER VERWENDETEN SYMBOLIK
DESCRIPCIÓN DE LOS SIMBOLOS UTILIZADOS**

1A Riferimento a figura / Référence à la figure / See figure
In Bezug auf Abbildungen / Referencia a la figura

1-1 Riferimento a componenti di fornitura / Référence aux composants de la fourniture
See supplied components / Bezug auf Gelieferte Einbauelemente
Referencia a los componentes de abastecimiento

1 Riferimento a posizione schema elettrico / Référence à la position du schéma électrique
See position in wiring diagram / In Bezug auf Position im Schaltschema /
Referencia a la posición del esquema eléctrico



- Lubrificare tutti i raccordi e gli O.R. con il nuovo olio refrigerante prima di collegarli

- Graisser tous les raccords et les O.R. avec le nouveau huile réfrigérant avant de les raccorder

-Lubricate all fittings and O-rings with new refrigerant oil before connecting them

- Alle Verbindungsstücke und OR-Ringe vor deren Verbindung mit dem neuen Kühlmittelöl ölen

- Lubrificar todos los empalmes y los O.R. con el nuevo aceite refrigerante antes de conectarlos

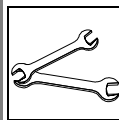

- Per avvitare a fondo o allentare i raccordi tubi gas usare due chiavi per bilanciare coppia di torsione

- Pour visser à fond ou desserrer les raccords des tuyaux gaz, utiliser le deux clés pour équilibrer le couple de torsion

- When tightening or loosening the fittings of the gas pipes, use two wrenches to equalize the torsion couple

- Um die Verbindungsstücke der Kältemittelschläuche gleichmäßig festzuschrauben oder zu lockern, zwei Schlüssel für das Verschraubungspaar verwenden

- Para enroscar a fondo o aflojar los empalmes tubos gas se deben usar dos llaves para balancear el par de torsión



- Tagliare con utensile appropriato al materiale

- Couper à l'aide d'outil approprié

- Cut with a device suitable for the material

- Mit dem Material entsprechendem Werkzeug schneiden

- Cortar con herramienta apropiada al material



- Tagliare con utensile a lama calda

- Couper à l'aide d'un outil à lame chaude

- Cut using the tool with heated blade.

- Mit Schweißmesserwerkzeug schneiden

- Cortar con útil a hoja caliente

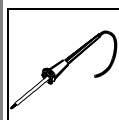

- Stagnare

- Étamer

- Tin

- Verzinnen

- Estañar



- Spianare

- Nivelar

- Flatten out

- Richten

- Nivelar

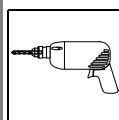

- Forare

- Percer

- To drill

- Durchbohren

- Taladrar

Pos.	ITALIANO	FRANÇAIS	ENGLISH	DEUTSCH	ESPAÑOL
31	Condensatore	Condenseur	Condenser	Kondensator	Condensador
32	Sacchetto accessori	Sachet accessoires	Bag of accessories	Säckchen mit Zuberhörteilen	Bolsita accesorios
35	Distanziale	Entretoise	Shim	Absandsstück	Distanziador
36	Supporto condensatore	Support condenseur	Condenser support	Kondensatorhalter	Suporte condensador
41	Sacchetto flangia	Sachet bride	Bag of flanges	Säckchen mit Flansch	Bolsita brida
42	Staffa di supporto tubi gas	Etrier support des tuyaux gaz	Gas pipe support bracket	Kältemittelschlauch Haltebügel	Abrazadera de soporte tubos gas
43 49	Fascetta in gomma	Collier en caoutchouc	Rubber clamp	Gummischelle	Banda de goma
44-45 50	Fermatubo	Fixation tuyau	Pipe clamp	Schlauchbinder	Detiene tubo
46	Protezione a spirale	Protection en spirale	Spiral protection	Spiralförmige Ummantelung	Protección a espiral
47	Relay interruttore	Relais interrupteur	Switch relay	Relaisschalter	Relé interruptor
48	Trasduttore di pressione	Capteur de pression	Pressure transducer	Druckwandler	Transductor de presión
48.1	Cablaggio per trasduttore di pressione	Câblage pour capteur de pression	Wiring for pressure transducer	Kabelstrang für Druckwandler	Cableado para transductor de presión
51	Filtro essiccatore	Filtre déshydrateur	Receiver drier	Trocknerfilter	Filtro secador
52	Staffa filtro	Etrier filtre	Receiver drier bracket	Filterbügel	Abrazadera filtro
61	Batteria evaporante	Batterie évaporateur	Evaporating unit	Verdampferbatterie	Batería evaporante
62	Sacchetto accessori	Sachet accessoires	Bag of accessories	Säckchen mit Zuberhörteilen	Bolsita accesorios
63	Distributore tubi gas	Distributeur tuyaux gaz	Gas pipe distributor	Kältemittelschlauchverteiler	Distribuidor tubos gas
64	Termostato	Thermostat	Thermostat	Thermostat	Termostato
65	Staffa supporto termostato	Etrier support thermostat	Thermostat support bracket	Thermostat-Haltebügel	Abrazadera soporte termostato
66	Molla fissaggio bulbo	Ressort fixation bulbe	Thermoswitch fixing spring	Kolben-befestigungsfeder	Muelle de fijación del bulbo
67	Pomello	Bouton	Knob	Drehkopf	Pomo
68	Mastice anticondensa	Mastic anti-condensation	Condensation-proofing material	Kondensatordichtungsmasse	Masilla anticondensación
69	Fascetta LOOPING	Collier LOOPING	Clamp LOOPING	Schelle LOOPING	Banda LOOPING
70	Tubo scarico condensa	Tuyau d'écoulement des condensations	Condensate drain pipe	Kondensatordrainrohr	Tubo descarga condensación
71	Valvola di espansione	Soupape d'expansion	Expansion valve	Expansionsventil	Válvula expansión
72	Flangia fissaggio valvola	Bride de fixation soupape	Valve fixing flange	Ventil-Befestigungsflansch	Brida de fijación de la válvula

Pos.	ITALIANO	FRANÇAIS	ENGLISH	DEUTSCH	ESPAÑOL
91	Impianto elettrico comandi	Faisceau électrique commandes	Electrical system for controls	Elektrische Anlage der Bedienungseinheit	Instalación eléctrica comandos
92	Giunzione RAYCHEM BLU	Raccord RAYCHEM BLEU	BLUE RAYCHEM connector	RAYCHEM Verbindung BLAU	Junta RAYCHEM TURQUI
93	Giunzione RAYCHEM ROSSA	Raccord RAYCHEM ROUGE	RED RAYCHEM connector	RAYCHEM Verbindung ROT	Junta RAYCHEM ROJO
94	Connettore PACKARD 1 via	Connecteur PACKARD à 1 voie	1-way PACKARD connector	1-Weg-PACKARD-Steckverbinder	Conector PACKARD 1 vía
100	Mascherina comandi	Plaque commandes	Control panel	Steuerungshalterung	Mascarilla mandos
106	Impianto elettrico elettroventole	Installation électrique electroventilateurs	Fans electric system	Elektrische Anlage Elektrolüfter	Instalación eléctrica electroventiladores
107-108 111-112	Cablaggio per centralina elettronica	Câblage pour dispositif de contrôle électronique	Wiring for electronic control unit	Kabelstrang für Elektronik-Box	Cableado para la central electrónica
109	Cablaggio supplementare	Câblage supplémentaire	Supplementary wiring	Zusatz-Kabelstrang	Cableado suplementario
110	Terminale	Borne	Terminal	Endstecker	Terminale
113	Giunzione RAYCHEM ROSSA	Raccord RAYCHEM ROUGE	RED RAYCHEM connector	RAYCHEM Verbindung ROT	Junta RAYCHEM ROJO
114	Connettore PACKARD 1 via	Connecteur PACKARD à 1 voie	1-way PACKARD connector	1-Weg-PACKARD-Steckverbinder	Conector PACKARD 1 vía
	Tubo gas 5/16"CF (condensatore-filtro)	Tuyau gaz 5/16"CF (condenseur-filtre)	5/16"CF gas hose (condenser-filter)	5/16"CF kaeltemittelschlauch (Kondensator-Filter)	Tubo gas 5/16"CF (condensador-filtro)
	Tubo gas 5/16"FE (filtro-evaporatore)	Tuyau gaz 5/16"FE (filtre-évaporateur)	5/16"FE gas hose (filter-evaporator)	5/16"FE kaeltemittelschlauch (Filter-Verdampfer)	Tubo gas 5/16"FE (filtro-evaporador)
	Tubo gas 13/32"CC (compressore-condensatore)	Tuyau gaz 13/32"CC (compresseur-condenseur)	13/32"CC gas hose (compressor-condenser)	13/32"CC kaeltemittelschlauch (Kompressor-Kondensator)	Tubo gas 13/32"CC (compresor-condensador)
	Tubo gas 1/2"EC (evaporatore-compressore)	Tuyau gaz 1/2"EC (évaporateur-compresseur)	1/2"EC gas hose (evaporator-compressor)	1/2"EC kaeltemittelschlauch (Verdampfer-Kompressor)	Tubo gas 1/2"EC (evaporador-compresor)
	Fascetta a strappo	Bride auto-bloquant	Self-locking clamp	Selbstsichernde Schelle	Banda autobloqueante



**MONTAGGIO CONDENSATORE / POSE DU CONDENSEUR / CONDENSER FITTING
KONDENSATOREINBAU / MONTAJE CONDENSADOR**

MATERIALE FORNITO / MATERIEL FOURNI / SUPPLIED MATERIAL / GELIEFERTES MATERIAL / MATERIAL ABASTECIDO

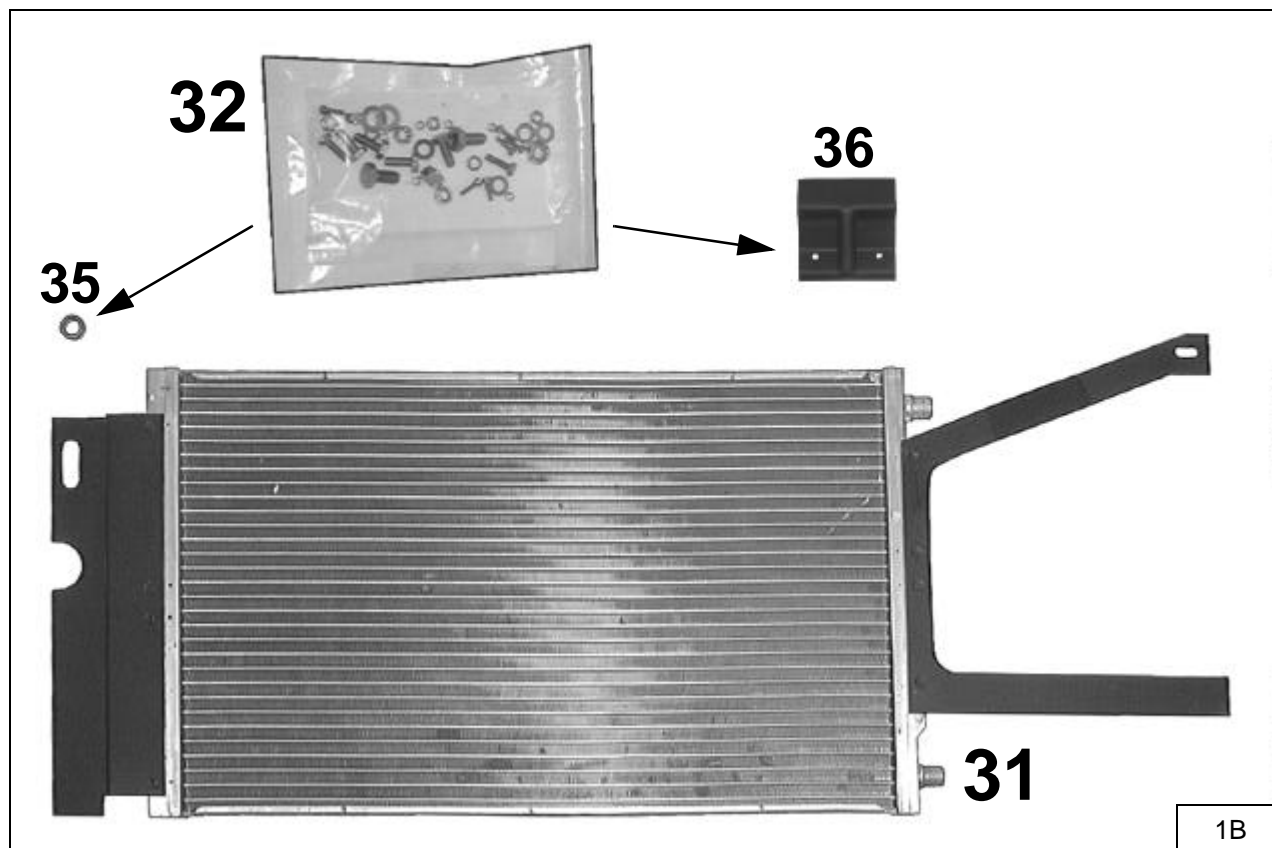

Pos.	Descrizione / Description / Description Beschreibung / Descripción	Codice / Code Kode / Código
31	Condensatore	024137/0
32	Sacchetto accessori	0231886/0
35	Distanziale $\phi 20 \times \phi 12 \times 9$	009966/0
36	Supporto condensatore	0322141/0

ELEMENTI DI FISSAGGIO / PIECES DE FIXATION FIXING PARTS / BEFESTIGUNGSELEMENTE ELEMENTOS DE FIJACION		
Pos.	Tipologia Typologie Typology Tipologie Tipologia	Descrizione Description Description Beschreibung Descripción
31.2		6x20

2B

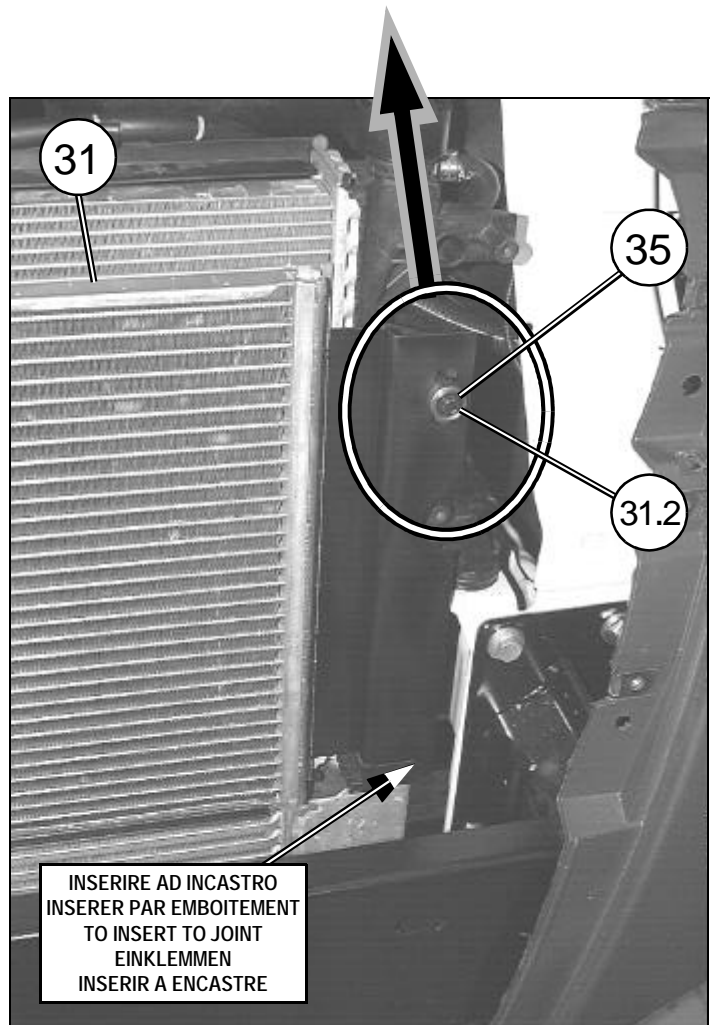
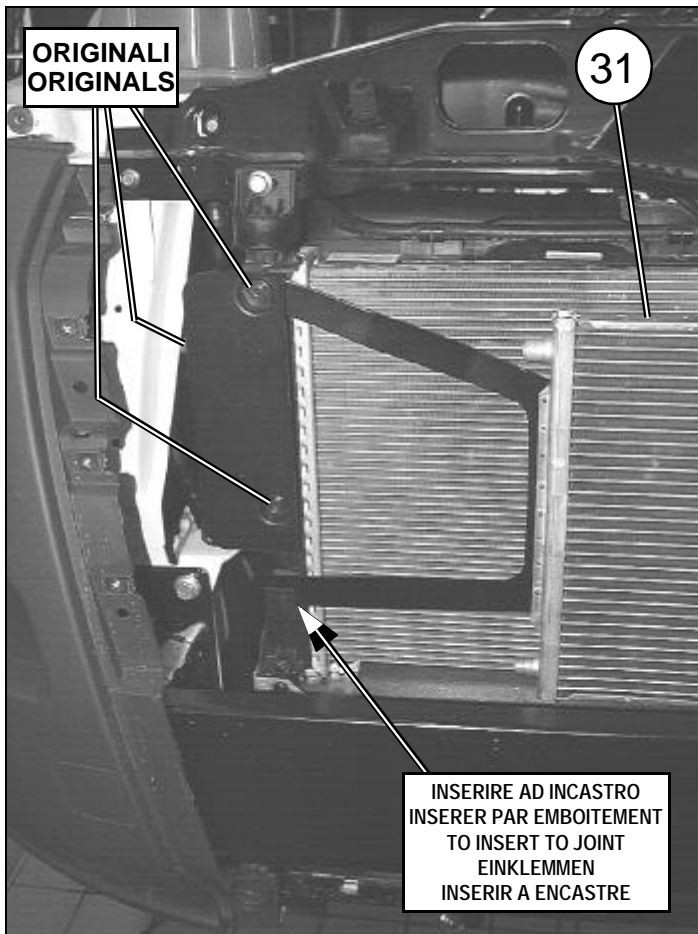
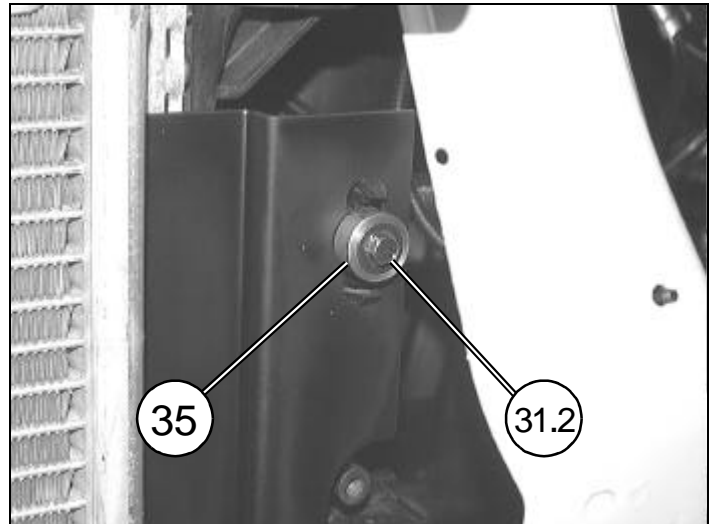

3B

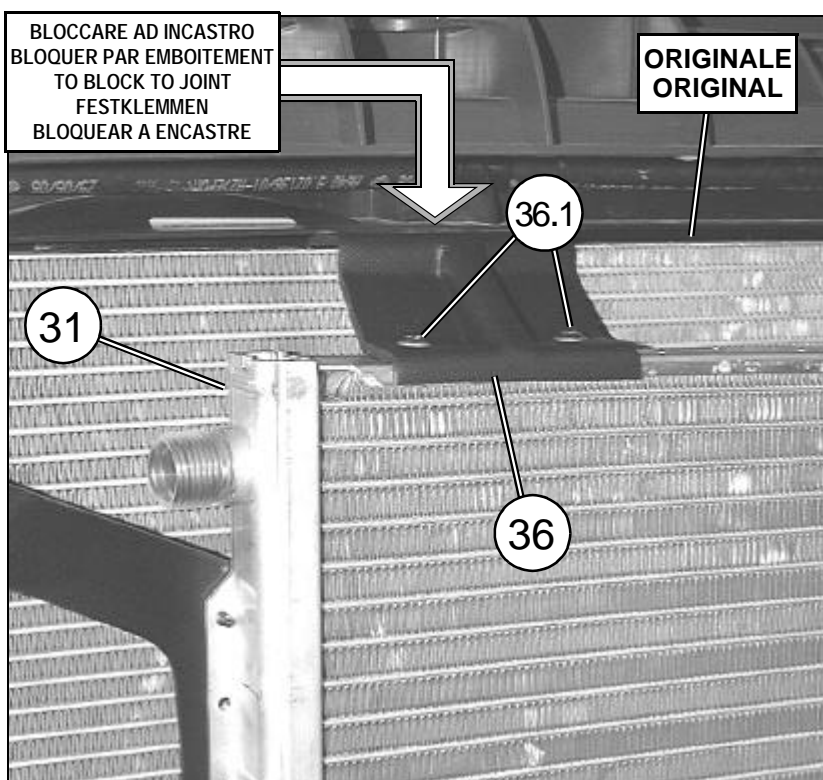
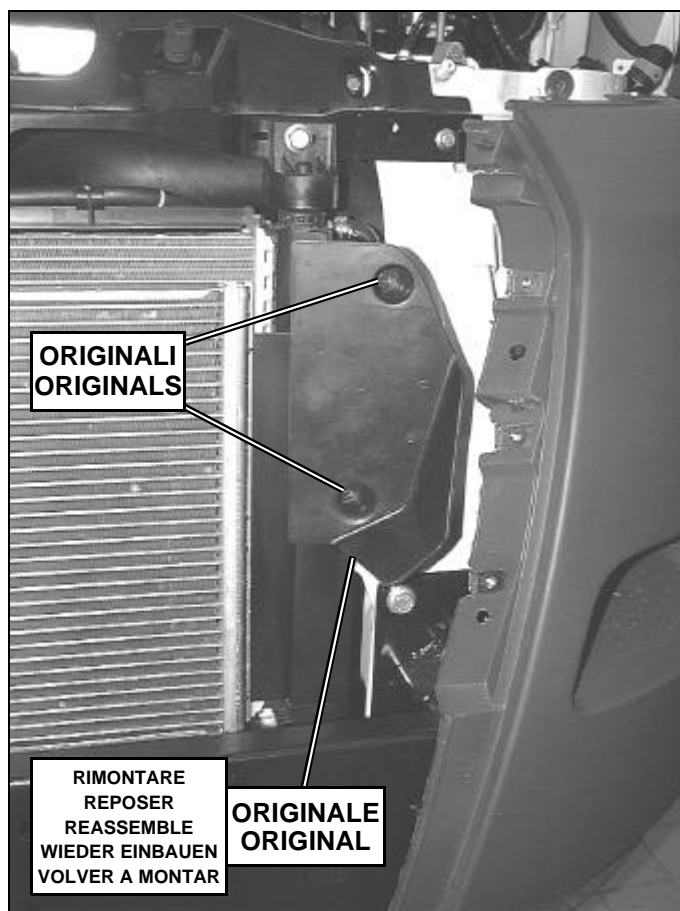

4B

ELEMENTI DI FISSAGGIO / PIECES DE FIXATION FIXING PARTS / BEFESTIGUNGSELEMENTE ELEMENTOS DE FIJACION		
Pos.	Tipologia / Typologie Typology / Tipologie Tipologia	Descrizione / Description Description / Beschreibung Descripción
36.1		4,2x9,5

**MONTAGGIO FILTRO ESSICCATORE / POSE DU FILTRE DESHYDRATEUR / RECEIVER DRIER ASSEMBLY
TROCKNERFILTER EINBAU / MONTAJE DEL FILTRO SECADOR**

MATERIALE FORNITO / MATERIEL FOURNI / SUPPLIED MATERIAL / GELIEFERTES MATERIAL / MATERIAL ABASTECIDO



Pos.	Descrizione / Description / Description Beschreibung / Descripción	Codice / Code Code / Código
32	Sacchetto accessori	0231886/0
51	Filtro essiccatore	017047/1A
52	Staffa filtro	0361819/0

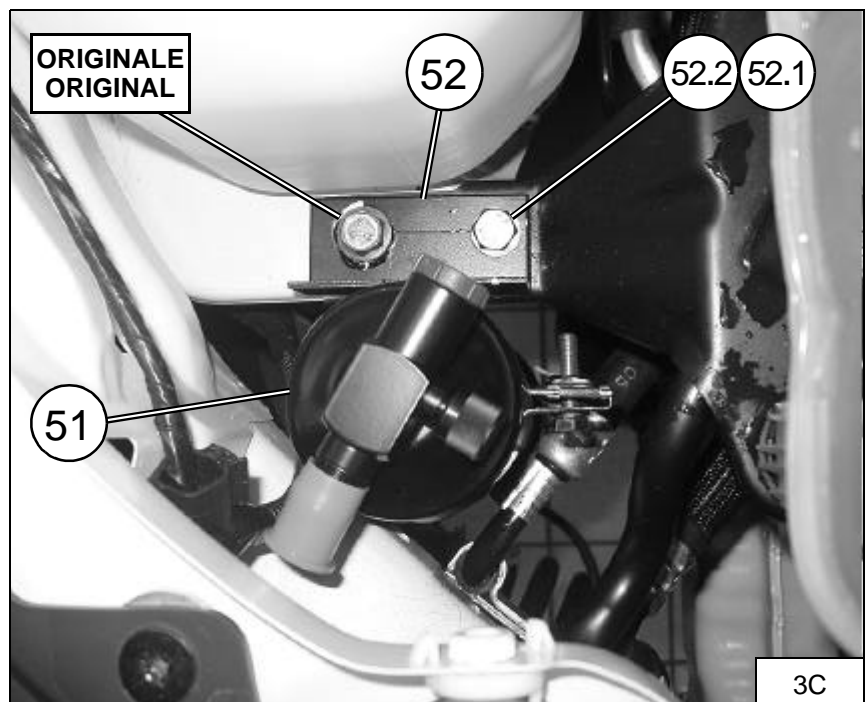
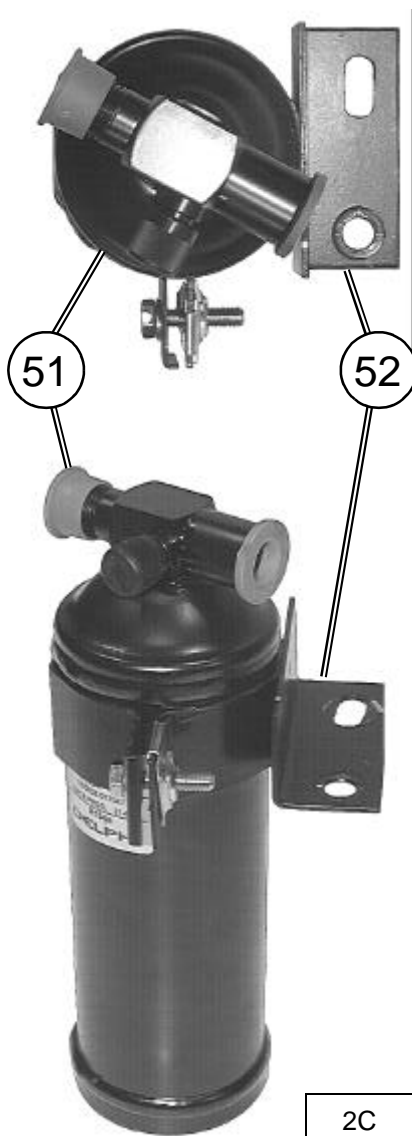

ELEMENTI DI FISSAGGIO / PIECES DE FIXATION FIXING PARTS / BEFESTIGUNGSELEMENTE ELEMENTOS DE FIJACION		
Pos.	Tipologia / Typologie Typology / Tipologie Tipologia	Descrizione / Description Description / Beschreibung Descripción
52.1		M8x20
52.2		φ8

MONTAGGIO COMPONENTI A.C. NELL'ABITACOLO (parte evaporante-comandi)
POSE DES COMPOSANTS A.C. DANS L'HABITACLE (évaporateur-commandes)
A.C. COMPONENTS ASSEMBLY IN THE PASSENGER COMPARTMENT (evaporator-controls)
EINBAU DER KLIMAANLAGEN-BESTANDTEILE IM WAGENINNEREN (Seite der Verdampfersteuerung)
MONTAJE COMPONENTES A.C. EN EL HABITACULO (parte evaporador-mandos)

MATERIALE FORNITO / MATERIEL FOURNI / SUPPLIED MATERIAL / GELIEFERTES MATERIAL / MATERIAL ABASTECIDO

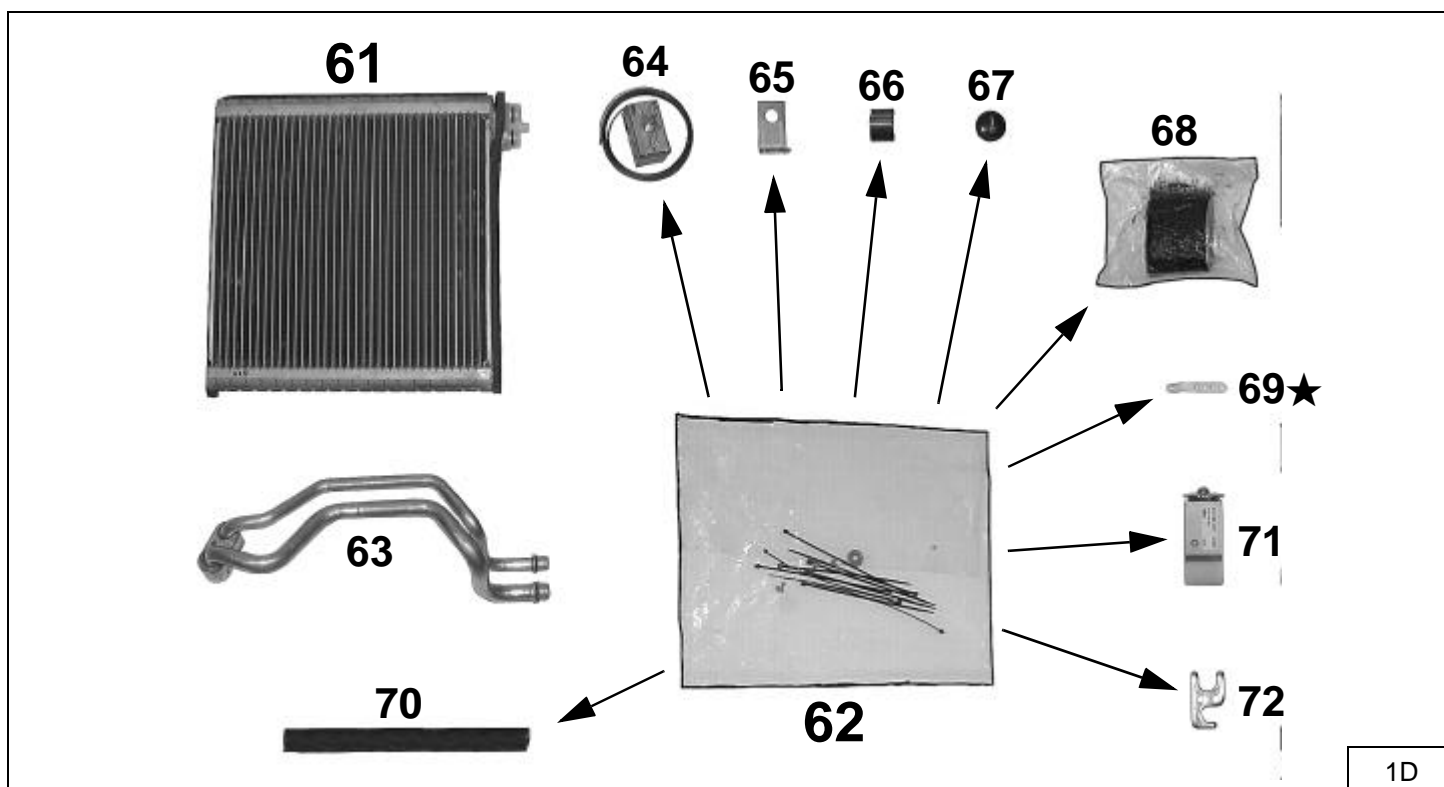

★ = Da non utilizzare nella presente installazione / A ne pas utiliser dans cette installation
 Not to be used in this installation / Nicht folgeden Einbau zu verwenden
 No hay que usar en la presente instalación

Pos.	Descrizione / Description Description / Beschreibung Descripción	Codice / Code Kode / Código
61	Batteria evaporante	052803/0
62	Sacchetto accessori	029932/0
63	Distributore tubi gas	043357/0
64	Termostato	0682242/0
65	Staffa supporto termostato	068165/0
66	Molla fissaggio bulbo	069180/0A

Pos.	Descrizione / Description Description / Beschreibung Descripción	Codice / Code Kode / Código
67	Pomello	068003/0A
68	Mastice anticondensa	0701407/0
69★	Fascetta LOOPING	069100/0
70	Tubo scarico condensa	011003.1
71	Valvola di espansione	058027/0A
72	Flangia fissaggio valvola	043060/0A

MATERIALE FORNITO / MATERIEL FOURNI / SUPPLIED MATERIAL / GELIEFERTES MATERIAL / MATERIAL ABASTECIDO

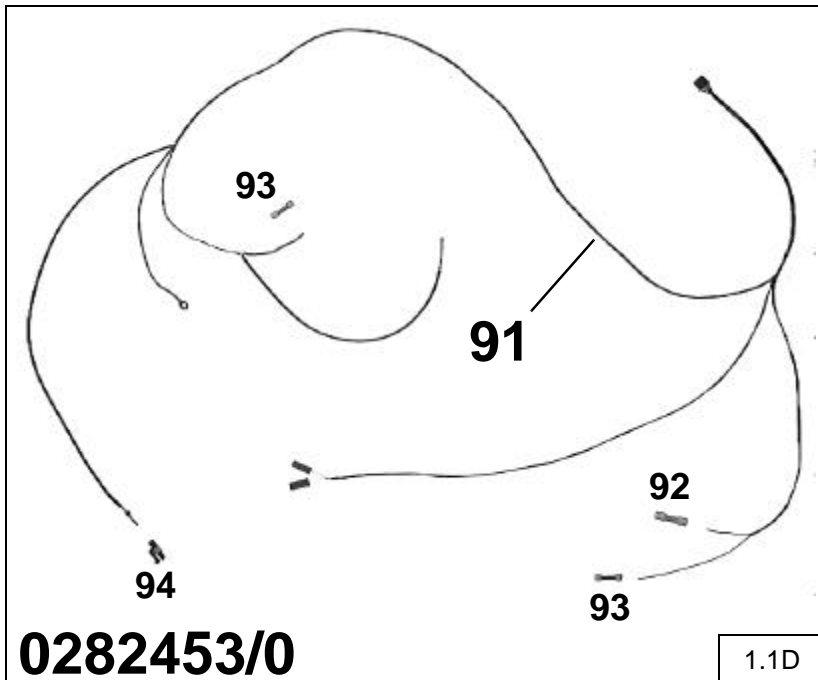

Pos.	Descrizione / Description Description / Beschreibung Descripción	Codice / Code Kode /Codigo
91	Impianto elettrico comandi	0282453/0
92	Giunzione RAYCHEM BLU	064273/0
93	Giunzione RAYCHEM ROSSA	064274/0
94	Connettore PACKARD 1 via	-

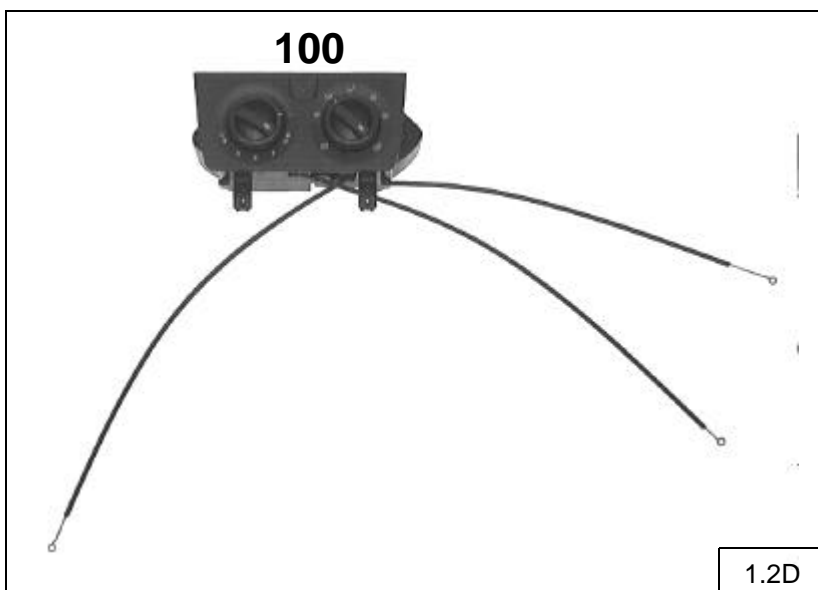

Pos.	Descrizione / Description Description / Beschreibung Descripción	Codice / Code Kode /Codigo
100	Mascherina comandi	0682771/0

OPERAZIONI PRELIMINARI / OPERATIONS PRELIMINAIRES / PRELIMINARY OPERATIONS
VORBEREITUNGSARBEITEN / OPERACIONES PRELIMINARES

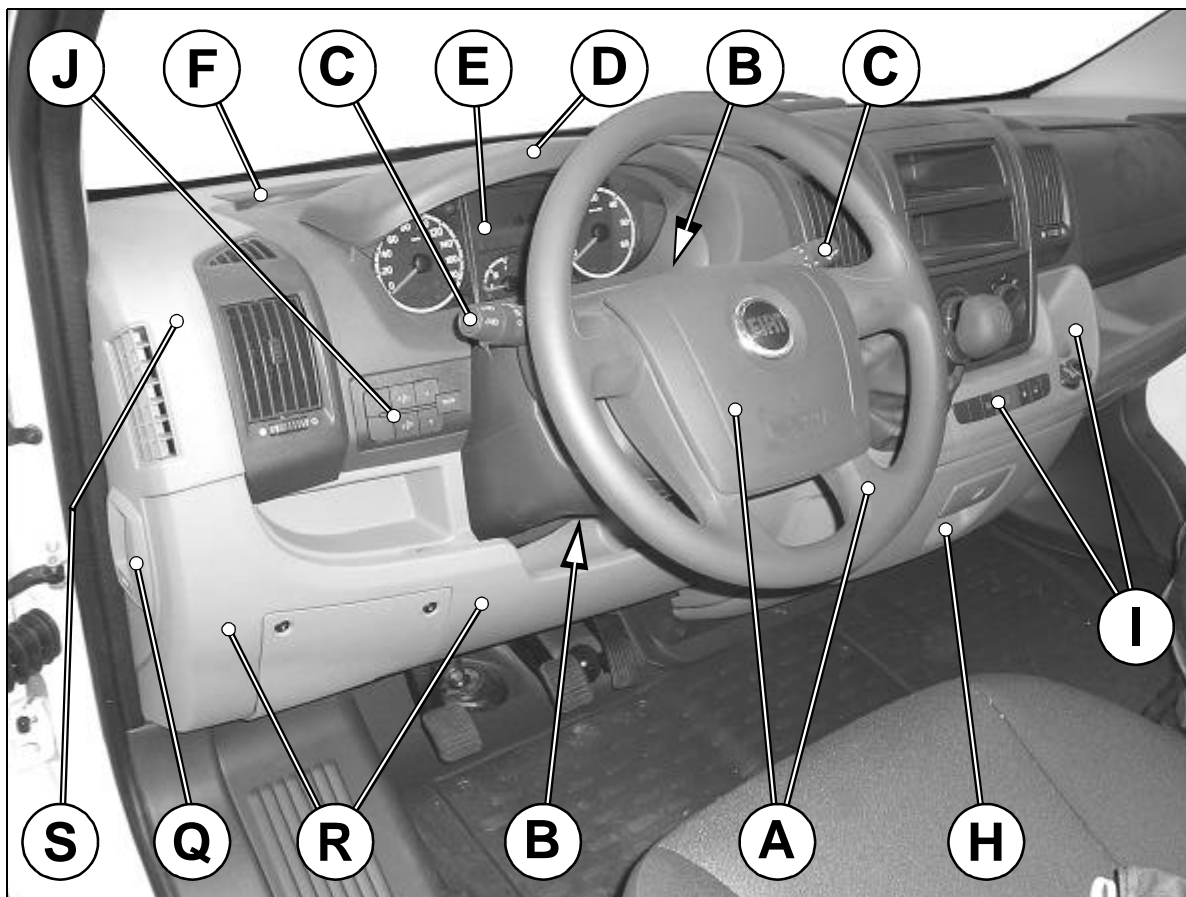

2D

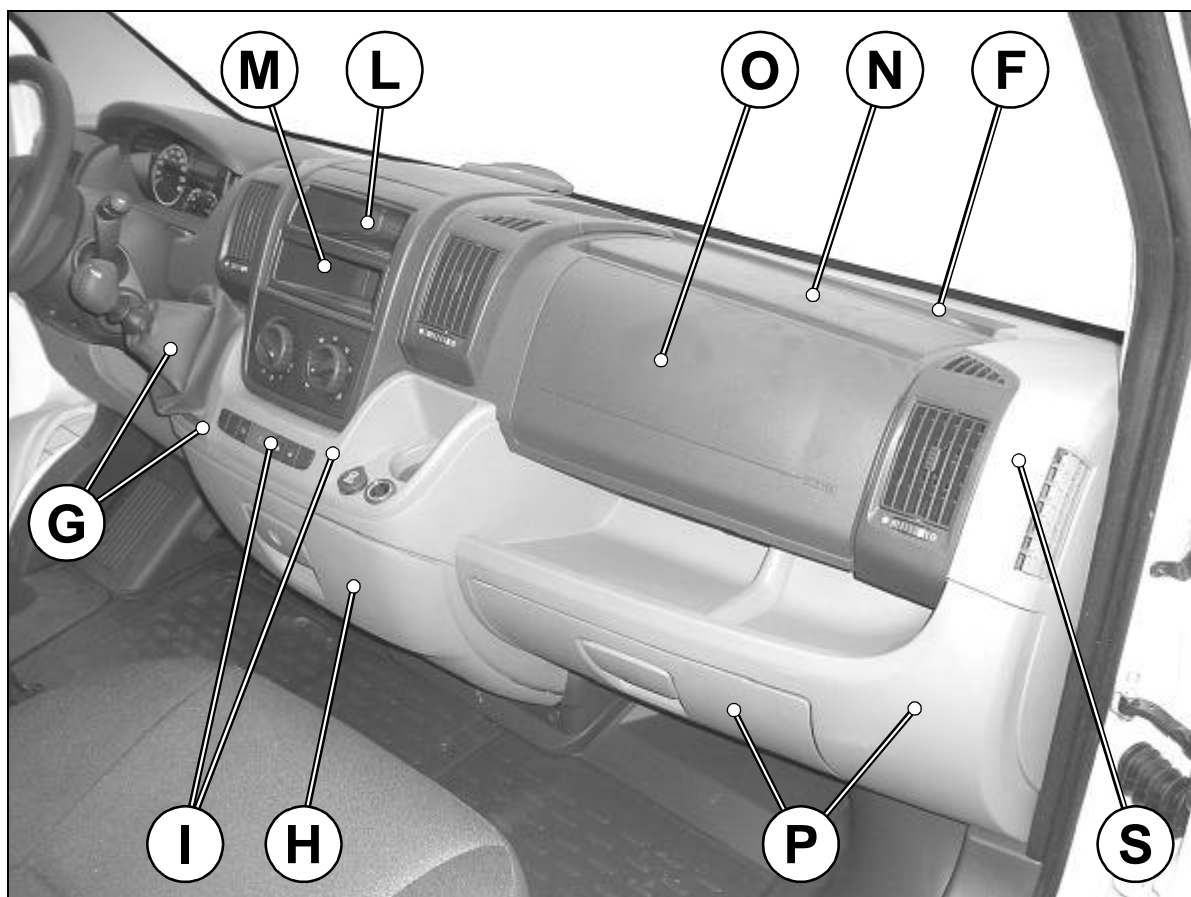

FIG. 2D

(I)

SMONTARE NELL'ABITACOLO:

A) AIR-BAG e volante (mantenere dritto il volante e bloccare l'anello di connessione con nastro adesivo); **B)** Copripiantone inferiore e superiore dello sterzo; **C)** Gruppo leveraggi di comando luci e tergicristalli; **D)** Cornice quadro strumentazione; **E)** Quadro strumentazione; **F)** Cornice defrost; **G)** Cornice e cuffia leva cambio; **H)** Vano porta-oggetti; **I)** Cornice centrale e gruppo interruttori di servizio; **J)** Gruppo interruttori di servizio; **L)** Vano porta-oggetti; **M)** Autoradio (se presente) e relativa cornice o vano di predisposizione; **N)** Vano porta-oggetti; **O)** AIR-BAG lato passeggero (se presente); **P)** Cornice e cassetto porta-oggetti; **Q)** Leva apertura cofano motore; **R)** Pannello sottopancia lato guida; **S)** Cruscotto scollegando tutti i collegamenti elettrici; **T)** Leva cambio; **U)** Barra trasversale, rimuovendo i fissaggi del piantone sterzo; **V)** Scollegare su lato vano motore i tubi acqua collegati al gruppo riscaldamento; **Z)** Gruppo riscaldamento.

(F)

DEPOSER DANS L'HABITACLE :

A) AIR-BAG et volant (maintenir le volant droit et fixer l'anneau de connexion à l'aide de ruban adhésif); **B)** Couvercle-colonne de direction inférieur et supérieur; **C)** Groupe leviers de commandes feux et essuie-glaces; **D)** Cadre tableau de bord; **E)** Tableau de bord; **F)** Cadre defrost; **G)** Cadre et protection pour levier de changement de vitesse; **H)** Compartiment vide-poche; **I)** Cadre central et groupe interrupteurs de service; **J)** Groupe interrupteurs de service; **L)** Compartiment vide-poche; **M)** Autoradio e cadre correspondant ou compartiment prévu; **N)** Compartiment vide-poche; **O)** AIR-BAG côté passager; **P)** Cadre et boîte à gants; **Q)** Levier d'ouverture du capot moteur; **R)** Panneau sous le tableau de bord côté conduite; **S)** Tableau de bord en déconnectant tous les branchements électriques; **T)** Levier de changement de vitesse; **U)** Barre transversale en éliminant les pièces de fixation colonne de direction; **V)** Déconnecter sur le côté compartiment moteur les tuyaux de l'eau connectés au groupe chauffage; **Z)** Groupe chauffage.

(GB)

REMOVE IN THE PASSENGER COMPARTMENT :

A) AIR-BAG and steering wheel (keep the steering wheel straight and tape down the connection ring); **B)** Upper and lower steering column casing; **C)** Light and windshield wiper control lever assembly; **D)** Instrument panel frame; **E)** Instrument panel; **F)** Defrost frame; **G)** Frame and gear lever guard; **H)** Glove compartment; **I)** Central frame and service switch assembly; **J)** Service switch assembly; **L)** Glove compartment; **M)** Radio (if there is one) and frame or arranged radio housing space; **N)** Glove compartment; **O)** Passenger side AIR-BAG (if there is one); **P)** Frame and glove box; **Q)** Hood release lever; **R)** Panel under the dashboard on driver's side; **S)** Dashboard disconnecting all electrical wires; **T)** Gear lever; **U)** Transverse bar by removing the steering wheel column fasteners; **V)** Disconnect the water hoses connected to the heating assembly on the side of the engine compartment; **Z)** Heater assembly.

(D)

VOM FAHRZEUGINNEREN AUSZUBAUEN:

A) AIR-BAG und Lenkrad (Das Lenkrad gerade halten und den Verbindungsring mit Klebeband blockieren); **B)** Untere und obere Lenksäulenabdeckung des Lenkrads; **C)** Bedienungshebel Licht und Scheibenwischer; **D)** Instrumententafelrahmen; **E)** Instrumententafel; **F)** Defrostrahmen; **G)** Rahmen und Ganghebelabdeckung; **H)** Handschuhkastens; **I)** Enbrettrahmen und des Bedienungsschalteinheit; **J)** Bedienungsschalteinheit; **L)** Handschuhkastens; **M)** Autoradio (wo vorhanden) und entsprechenden Rahmen oder vorgesehenen Raum; **N)** Handschuhkastens; **O)** AIR-BAG (wo vorhanden) Ausschaltungsvorrichtung; **P)** Rahmen und Handschuhkasten; **Q)** Öffnungshebel der Motorhaube; **R)** Abdeckung unter dem Armaturenbrett-Fahrerseite; **S)** Armaturenbrett-alle elektrischen Teile abklemmen; **T)** Gangschaltung; **U)** Querträger, indem die Befestigungen der Lenksäule gelöst werden; **V)** Die an Heizgerät angeschlossenen Wasser-schläuche an der Motorraumseite abklemmen; **Z)** Heizgeräteinheit.

(E)

DESMONTAR EL EN HABITÁCULO:

A) AIR-BAG y volante (tener el volante en posición recta y bloquear el anillo de conexión con tira adhesiva); **B)** Cubre columna inferior y superior del volante; **C)** Grupo del mecanismo de palancas de mando luces y limpiaparabrisas; **D)** Marco tablero de instrumentos; **E)** Tablero de instrumentos; **F)** Marco defrost; **G)** Marco y funda palanca de cambio; **H)** Espacio guantera; **I)** Marco central y grupo interruptores de servicio; **J)** grupo interruptores de servicio; **L)** Espacio guantera; **M)** Radioreceptor (si presente) y correspondiente marco o espacio de predisposición; **N)** Espacio guantera; **O)** AIR-BAG lado pasajero (si presente); **P)** Marco y cajón guantera; **Q)** Palanca apertura capot motor; **R)** Panel bajo placa lado del conductor; **S)** Tablero desconectando todas las conexiones eléctricas; **T)** Palanca de cambio velocidades; **U)** Barra transversal, eliminado las fijaciones de la columna de la dirección; **V)** Desconectar en el espacio motor los tubos agua conectados al grupo calefacción; **Z)** Grupo calefacción.

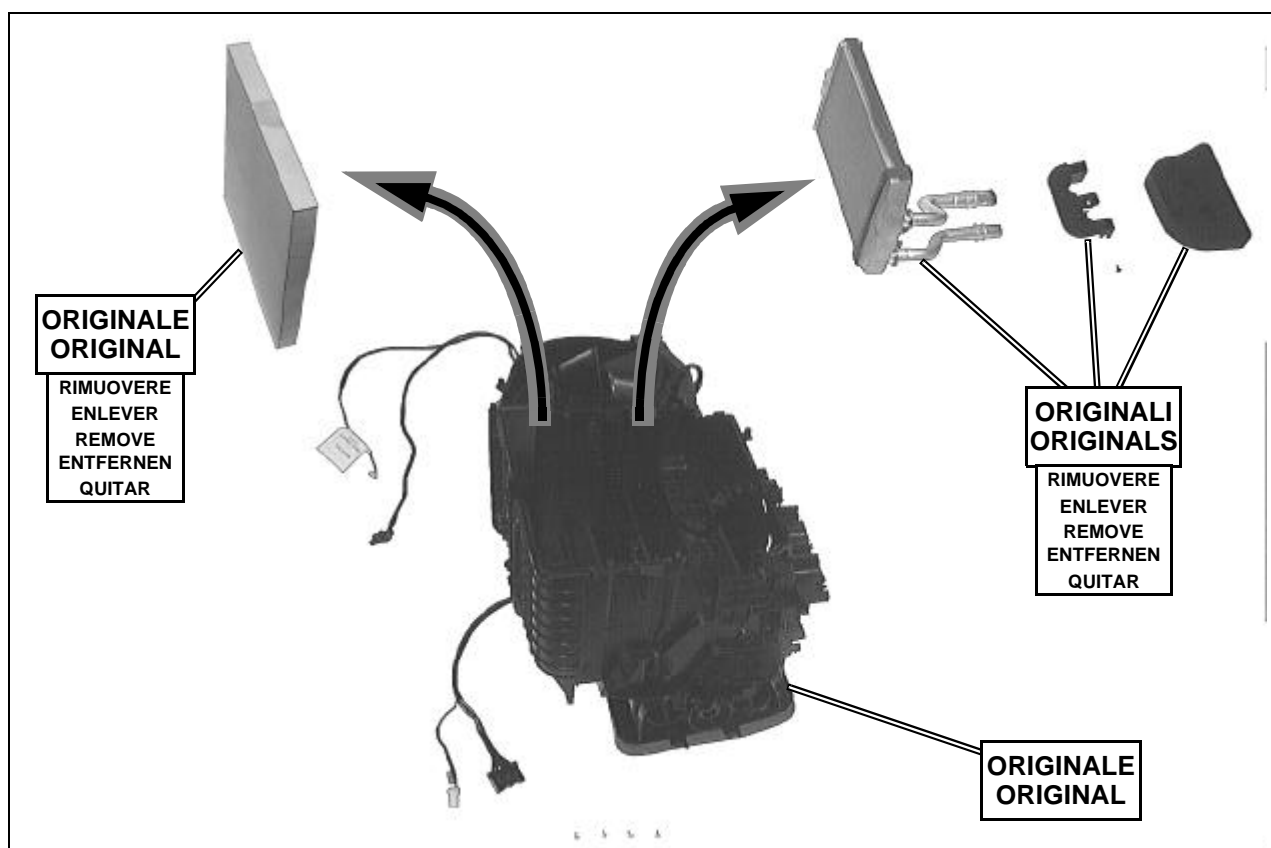
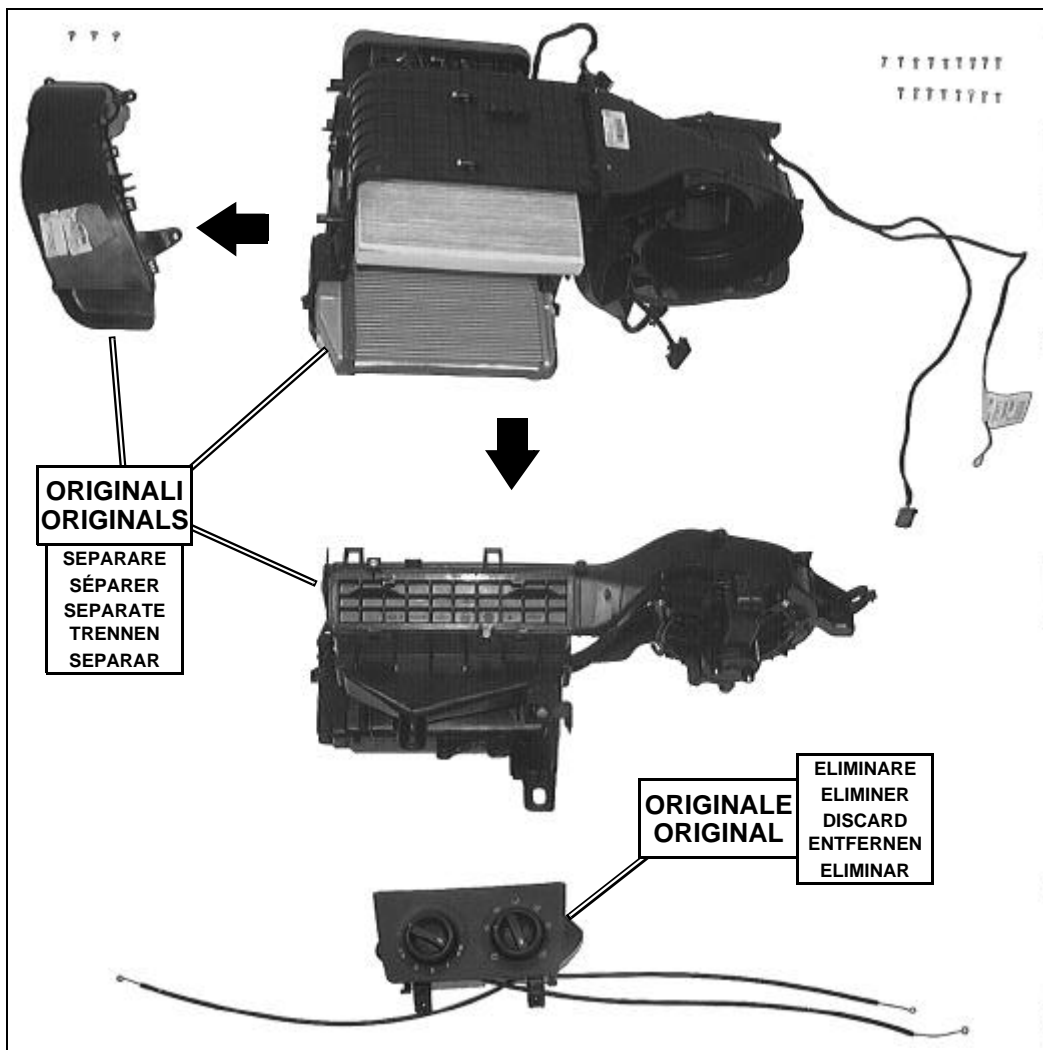

ORIGINALE
ORIGINAL

4D

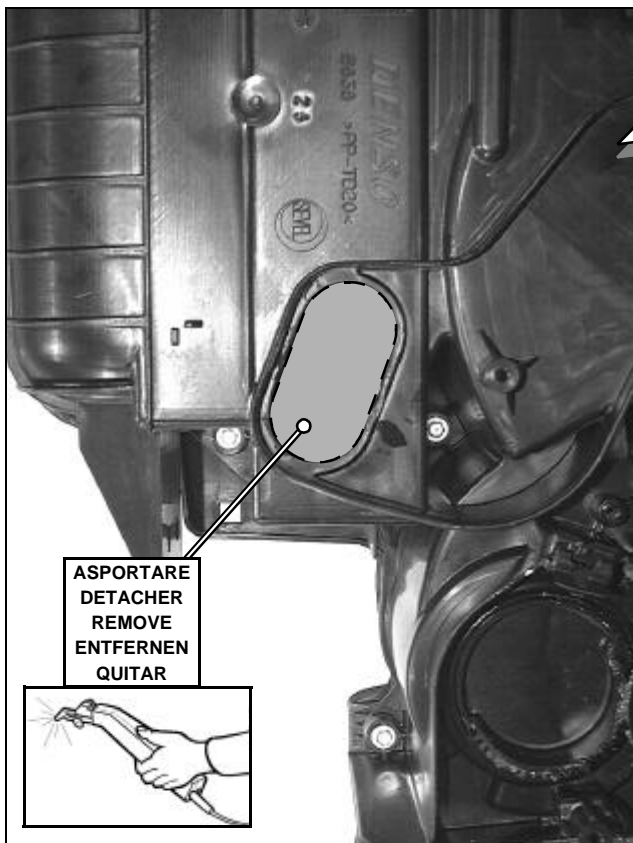

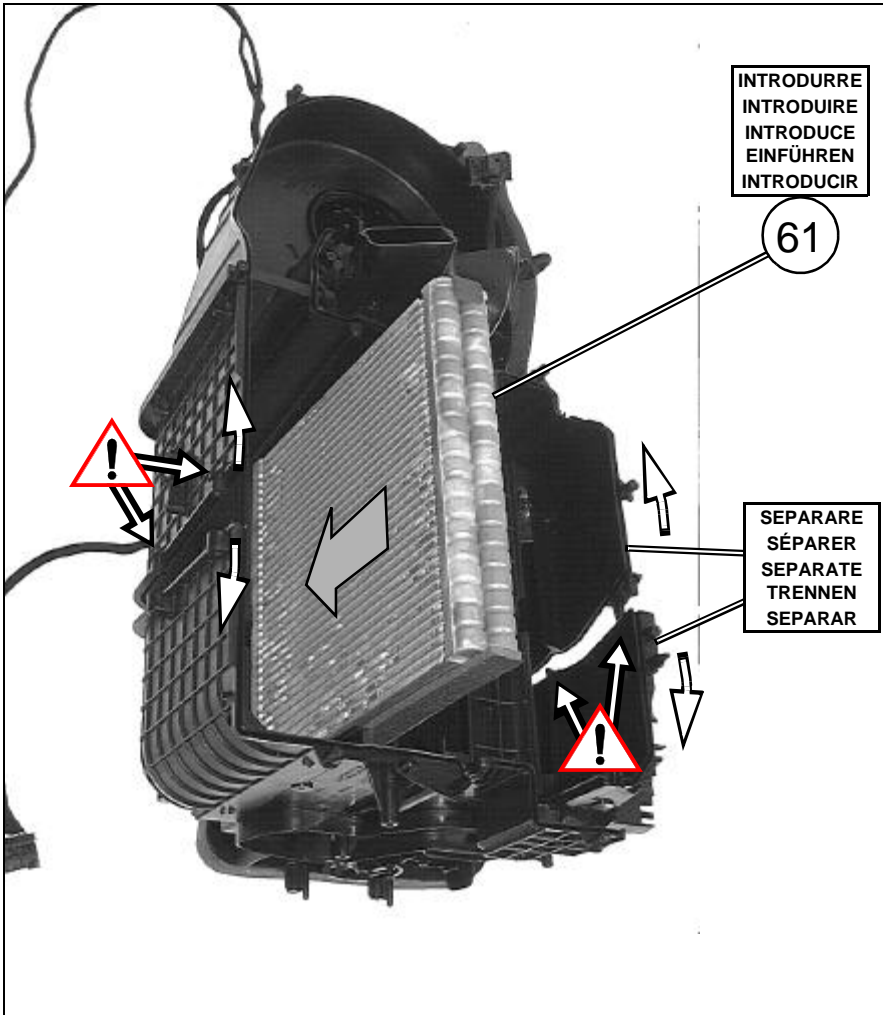

5D



(I)
ATTENZIONE: per facilitare l'introduzione della batteria evaporante "61" all'interno del gruppo riscaldamento, si consiglia di rimuovere momentaneamente i fissaggi dei due semigusci, nei punti indicati in figura.

(F)
ATTENTION: pour faciliter l'introduction de la batterie évaporateur "61" à l'intérieur du groupe chauffage, on conseille d'enlever momentanément les fixations des deux demi-coques, aux points indiqués sur la figure.

(GB)
WARNING: to facilitate inserting the evaporating unit "61" into the heating unit, we suggest you temporarily remove the elements securing the two halves at the points indicated in the figure.

(D)
ACHTUNG: Zur einfacheren Einführung der Verdampferbatterie "61" ins Innere der Heizgerätgruppe ist es ratsam kurzfristig die Befestigungen der beiden Schalenhälften in den in der Abbildung gezeigten Punkten zu entfernen.

(E)
ATENCIÓN: para facilitar la introducción de la batería evaporadora "61" dentro del grupo calefacción, se aconseja quitar momentáneamente las fijaciones de los dos semicascos, por los puntos indicados en la figura.

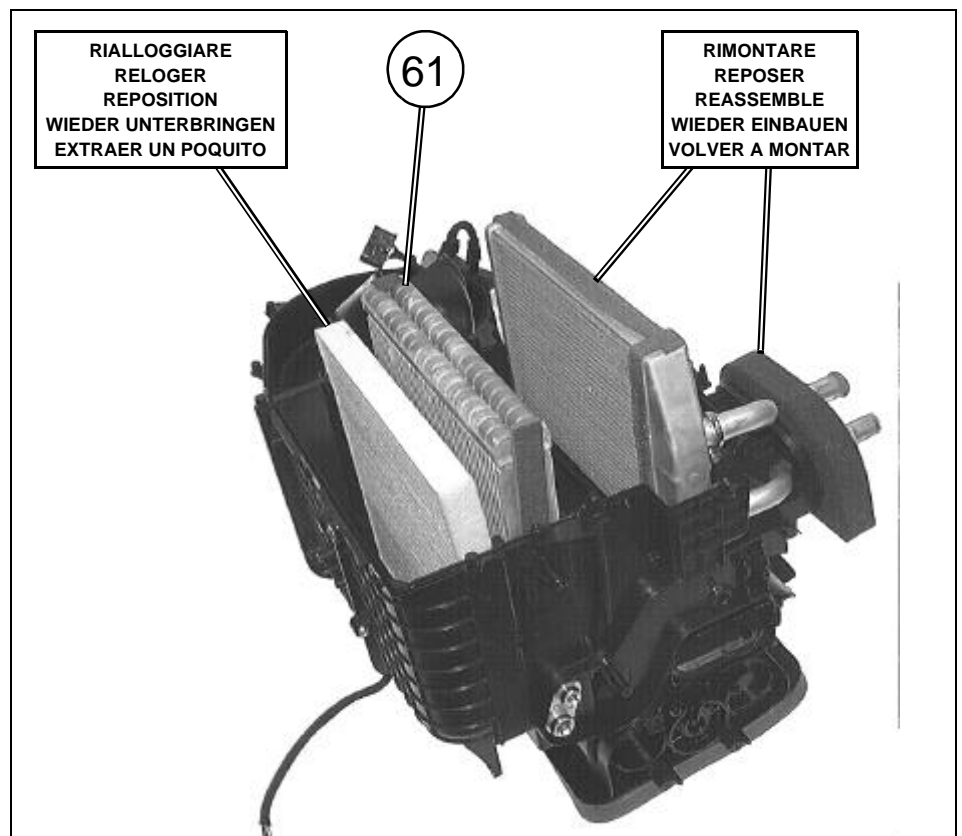

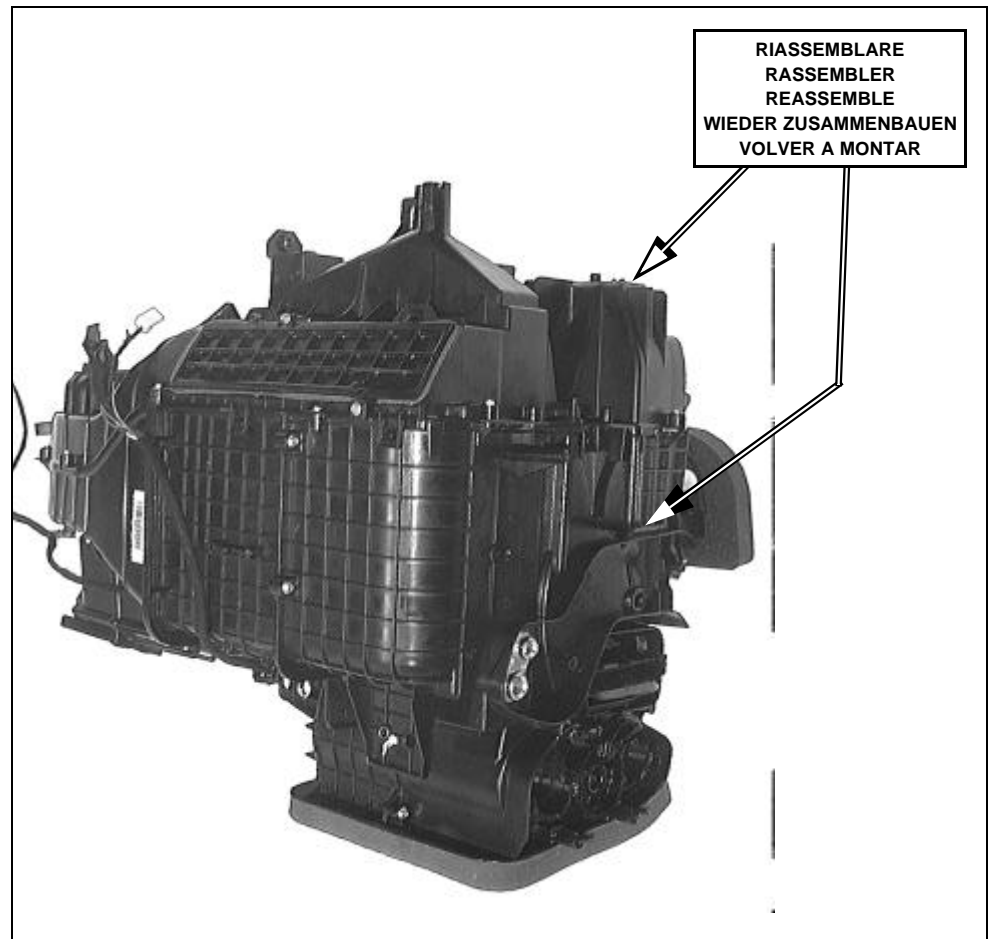
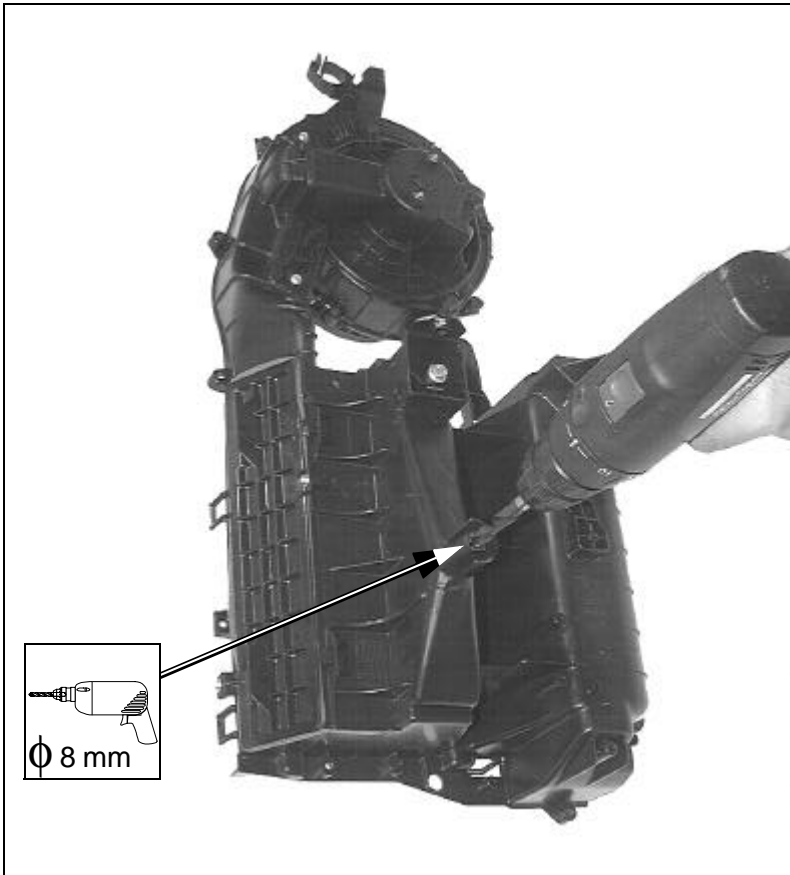

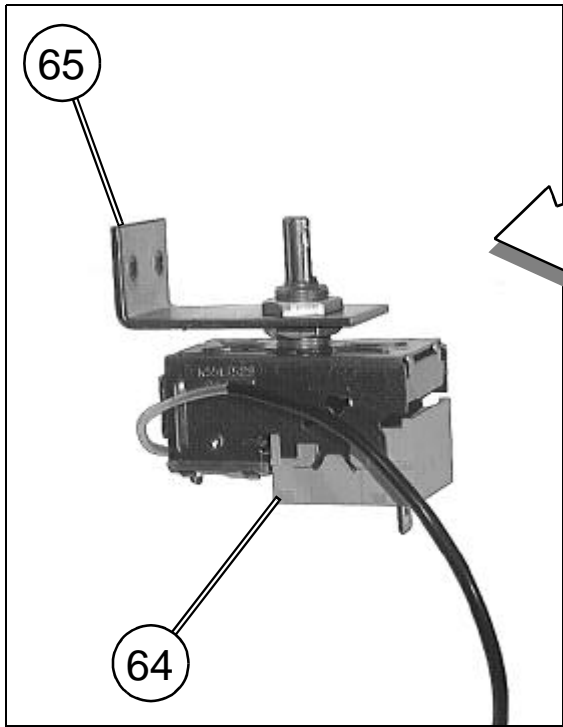

7D

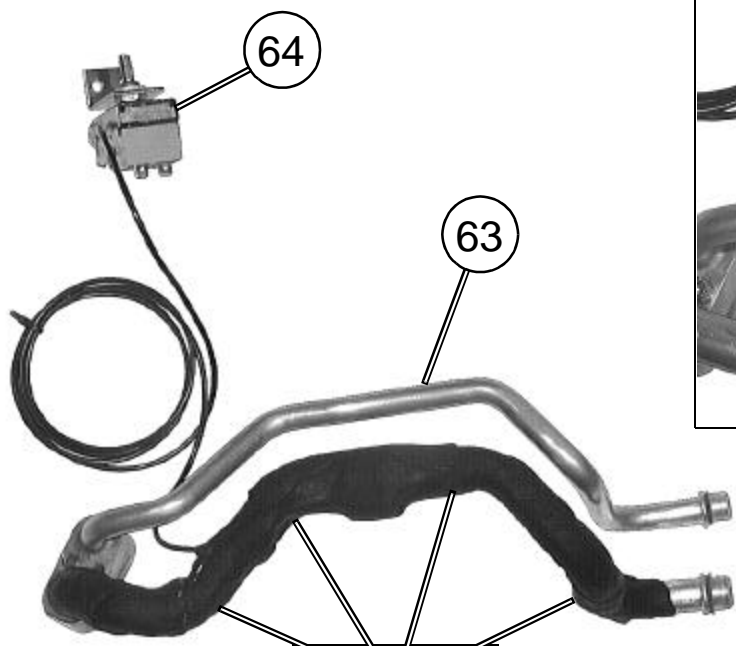
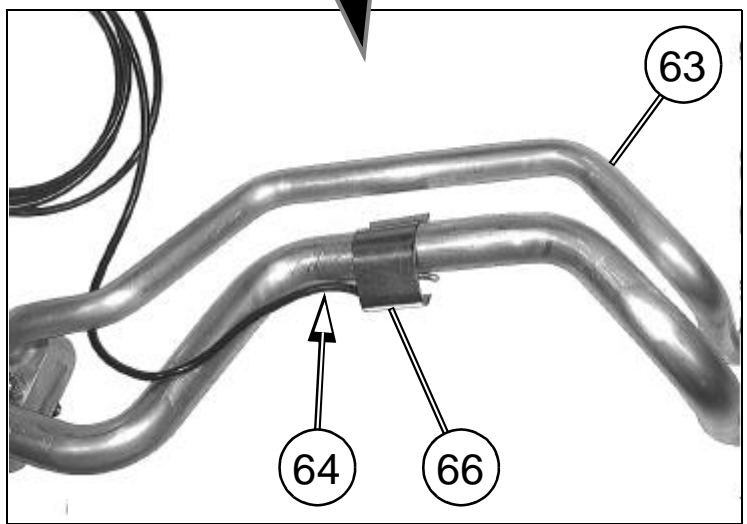
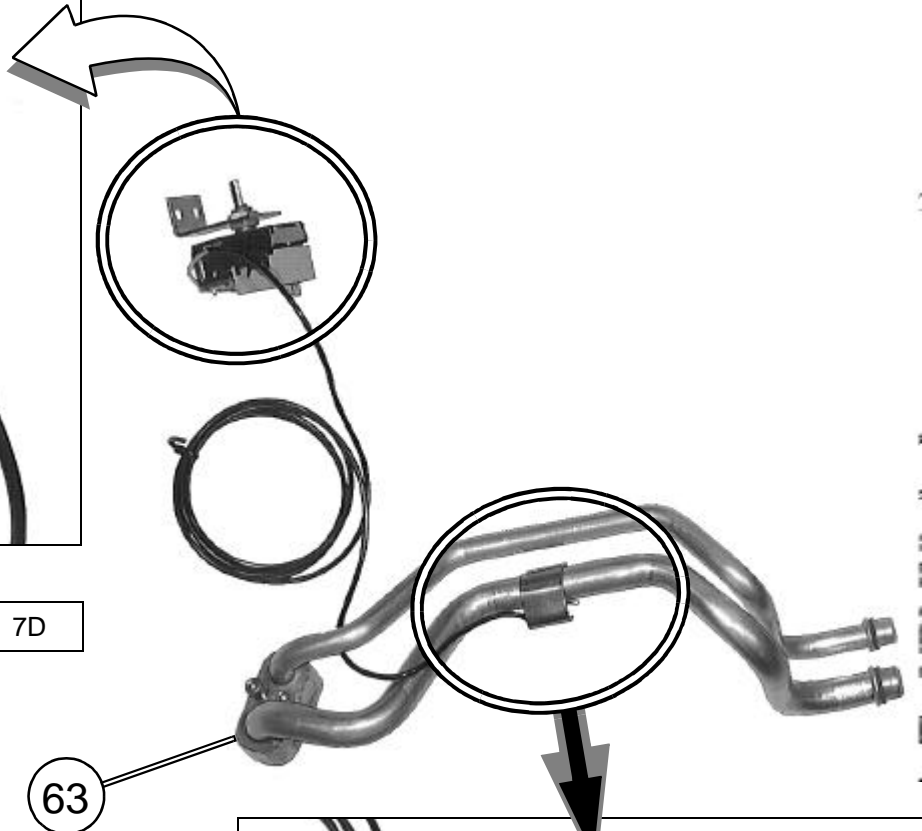

68
RIVESTIRE
RHABILLER
RECLOTHE
WIEDER EINKLEIDEN
VOLVER A VESTIR

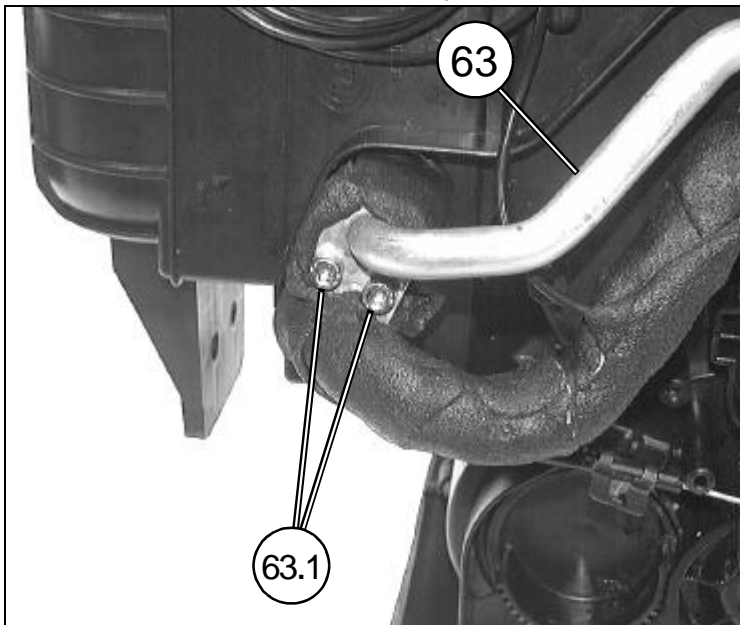
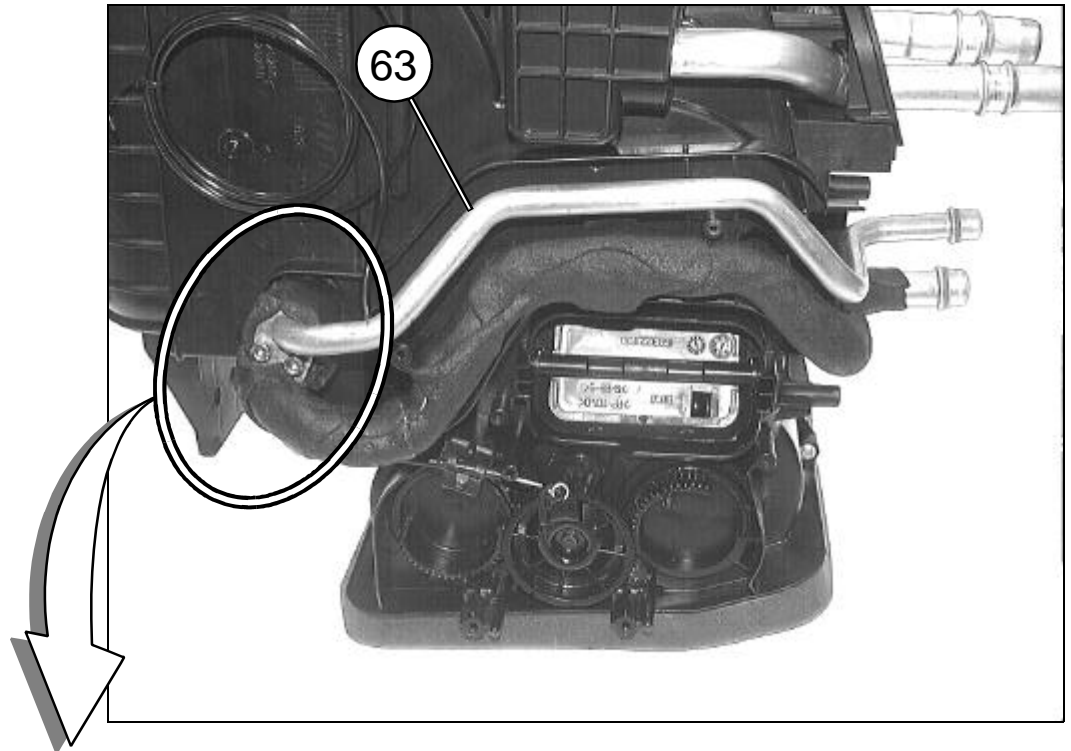

8D

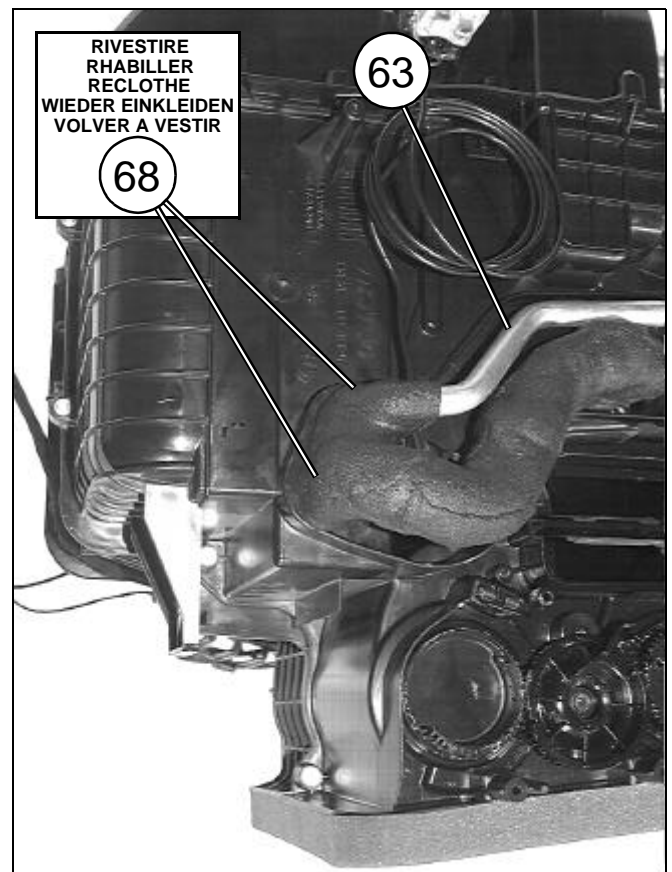

ELEMENTI DI FISSAGGIO PIECES DE FIXATION / FIXING PARTS BEFESTIGUNGSELEMENTE ELEMENTOS DE FIJACION		
Pos.	Tipologia Typologie Typology Tipologie Tipologia	Descrizione Description Description Beschreibung Descripción
63.1		M5x30

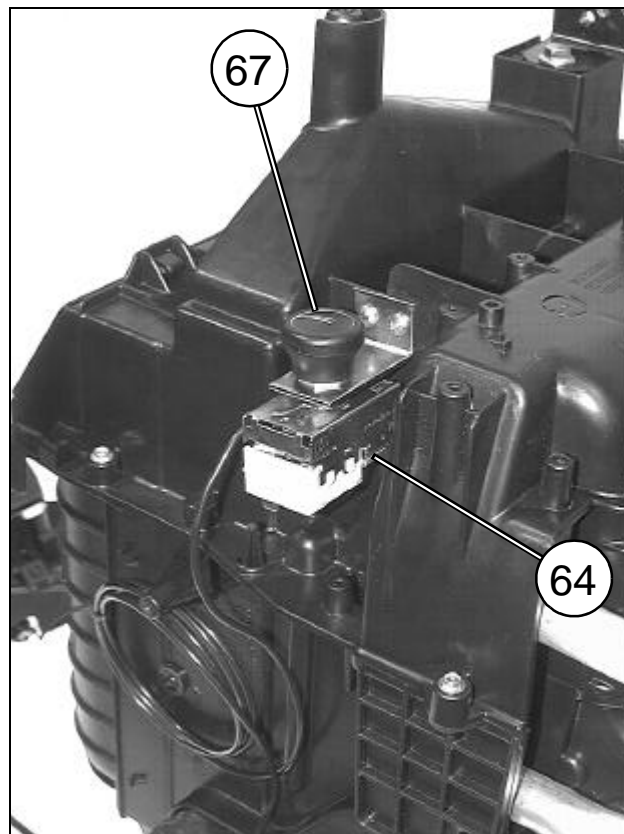
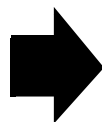
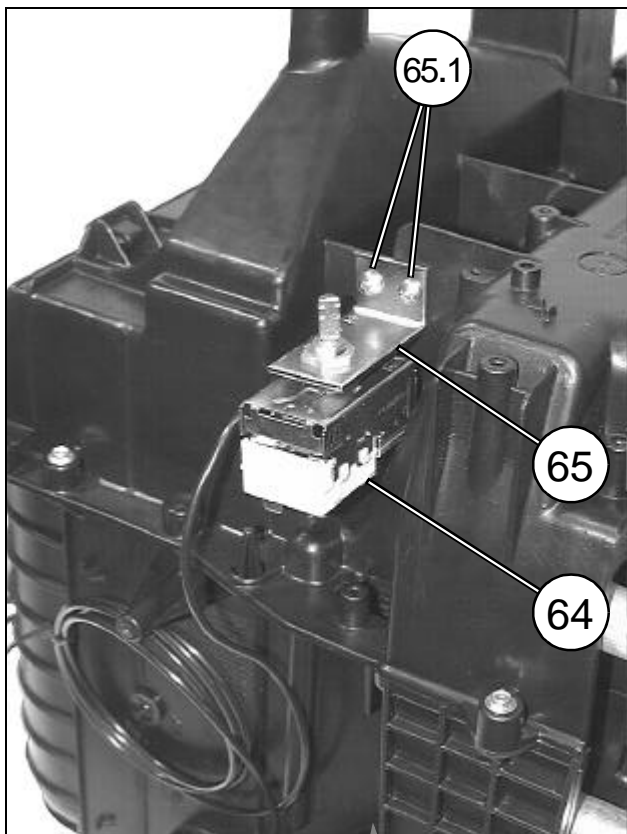

9D

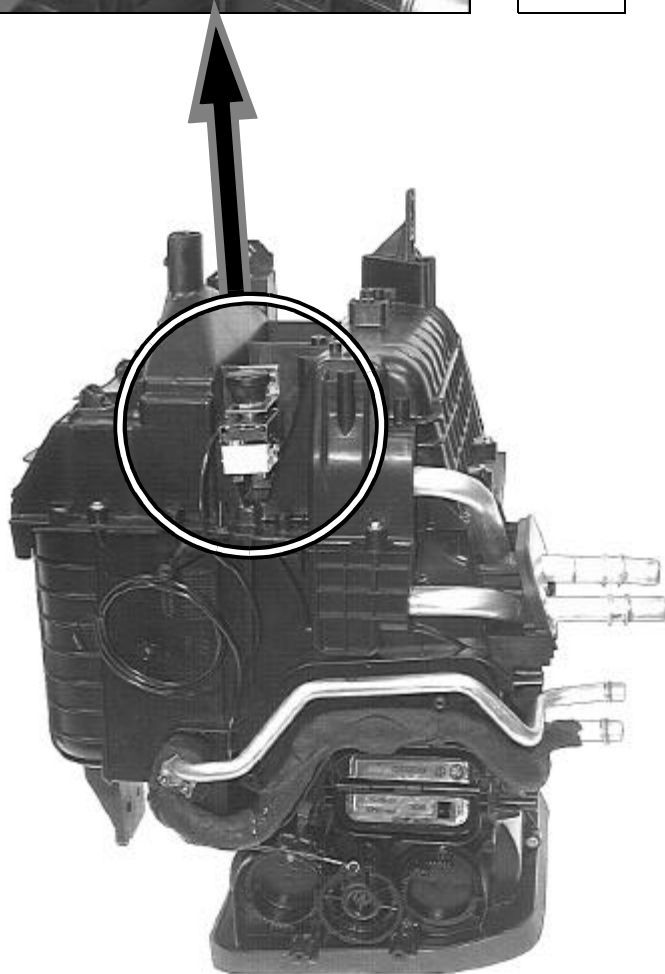

ELEMENTI DI FISSAGGIO PIECES DE FIXATION / FIXING PARTS BEFESTIGUNGSELEMENTE ELEMENTOS DE FIJACION		
Pos.	Tipologia Typologie Typology Tipologie Tipologia	Descrizione Description Description Beschreibung Descripción
65.1		4x10

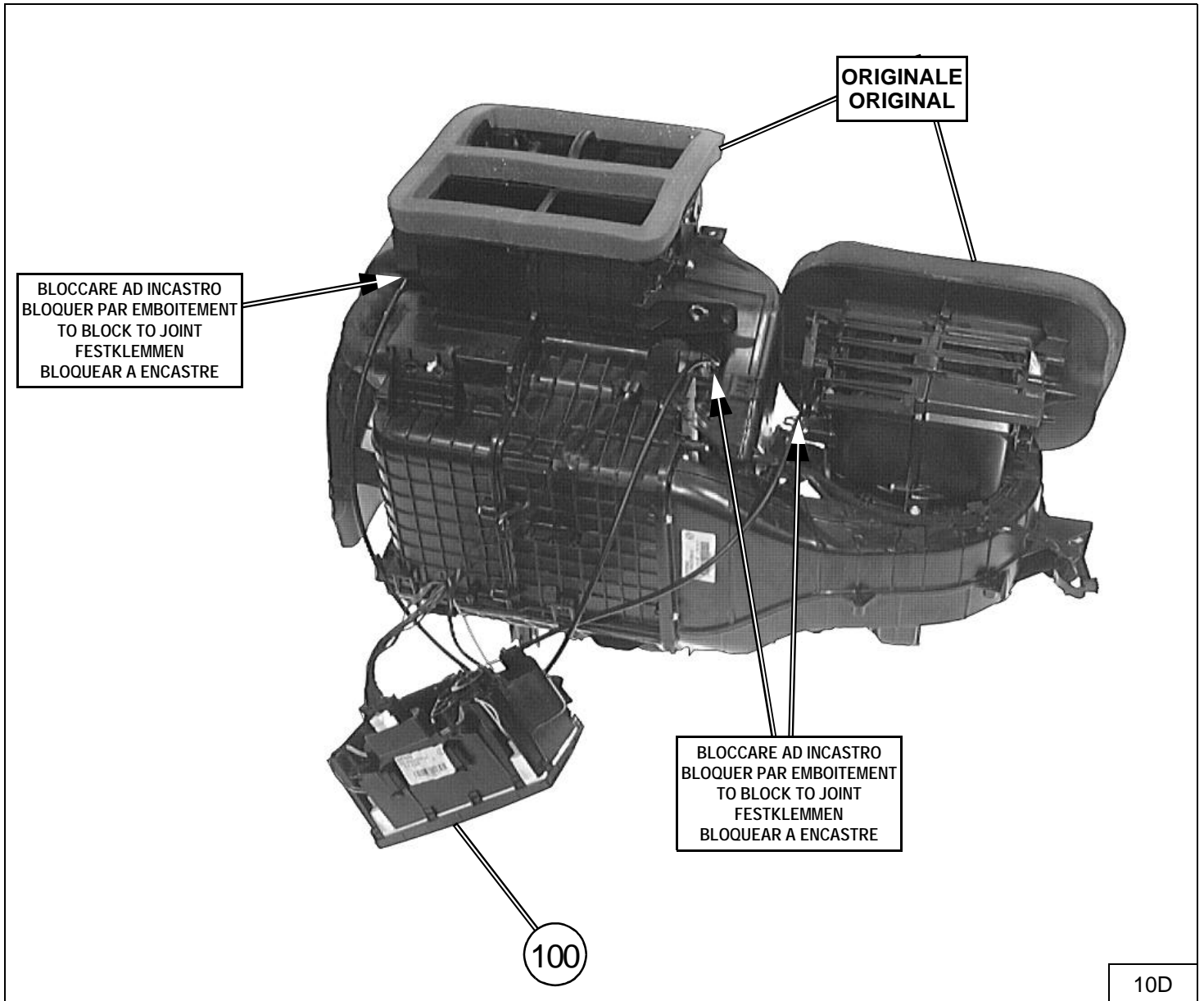

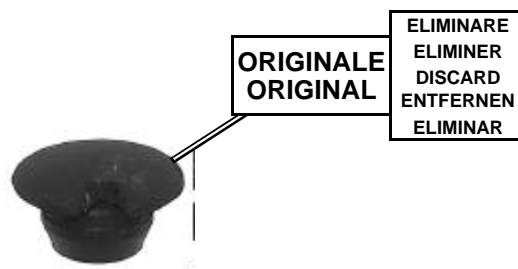
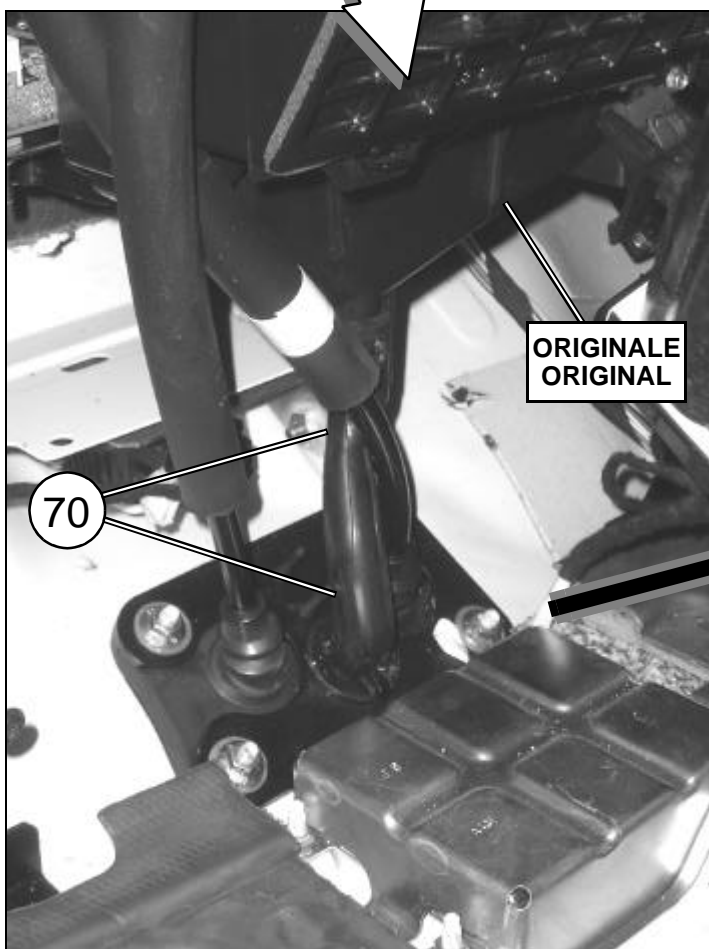
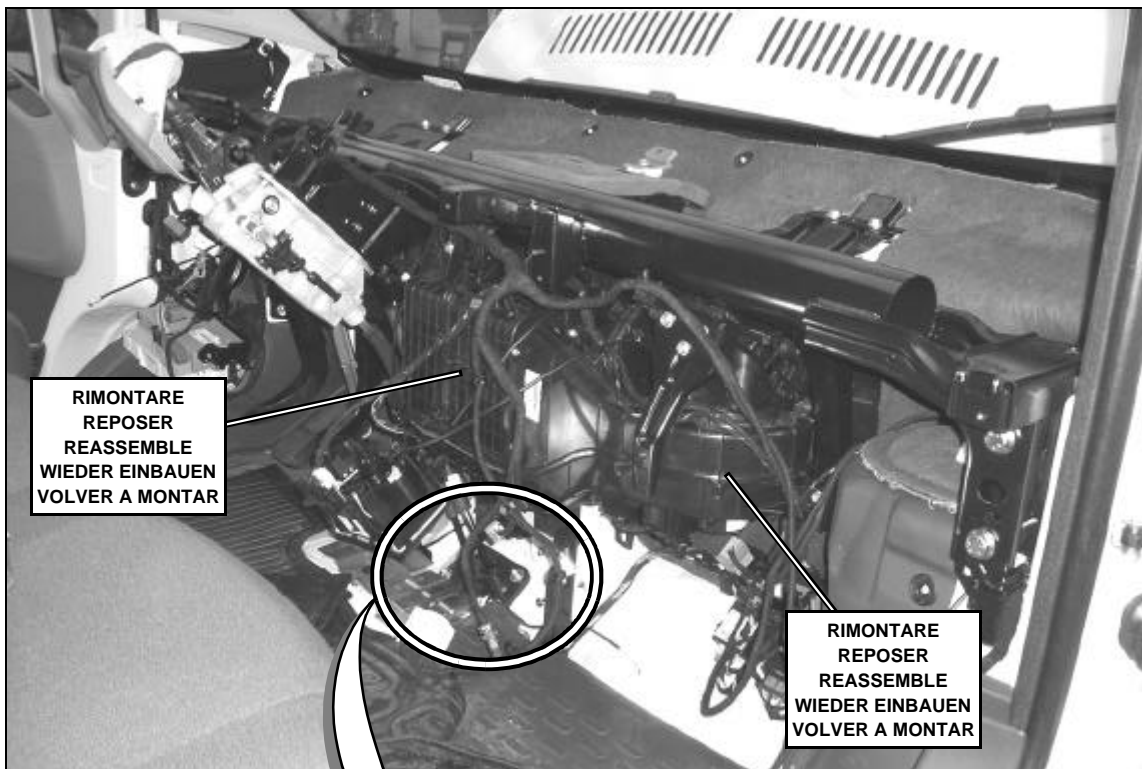



12D

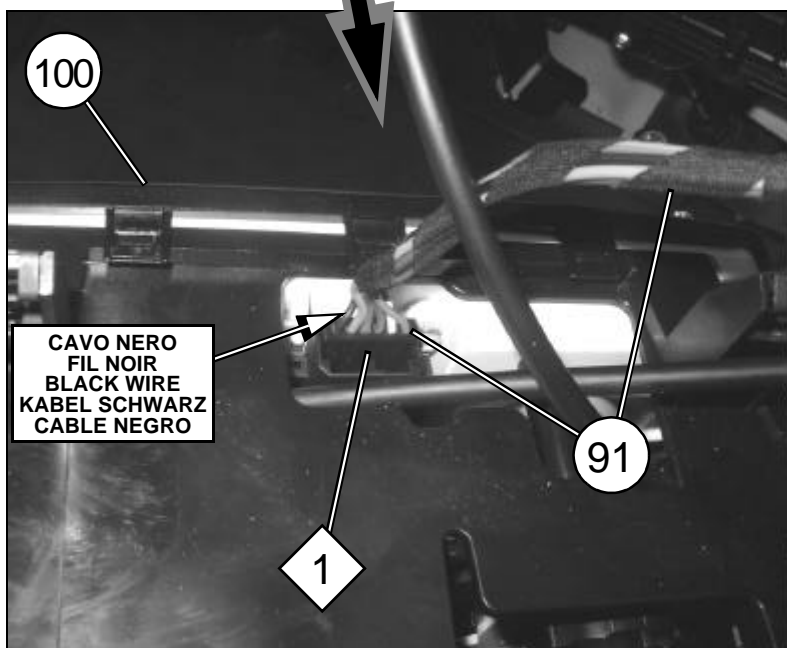
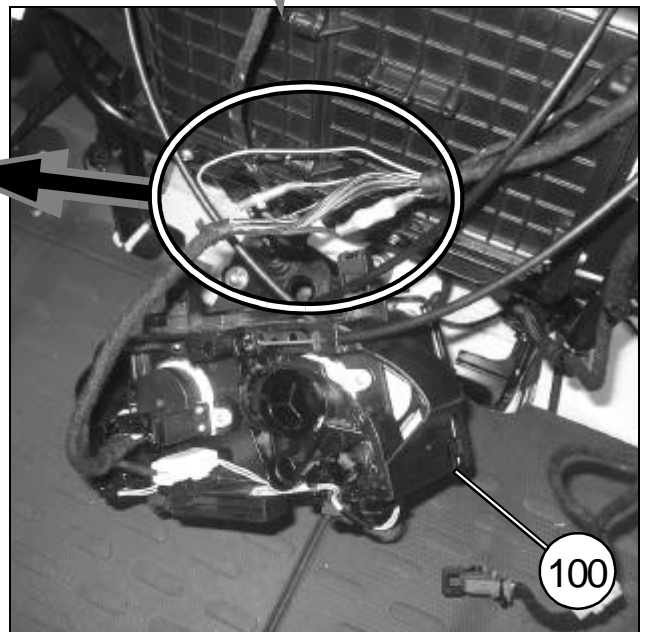
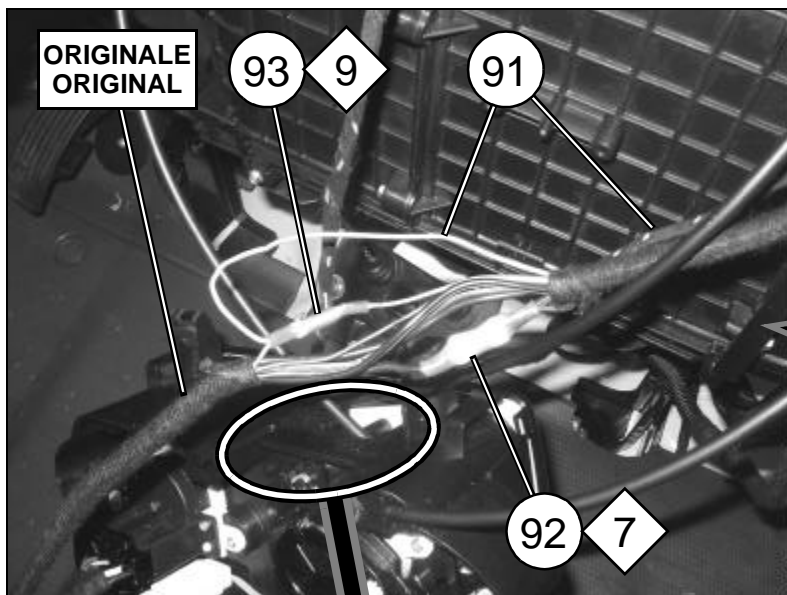



13D

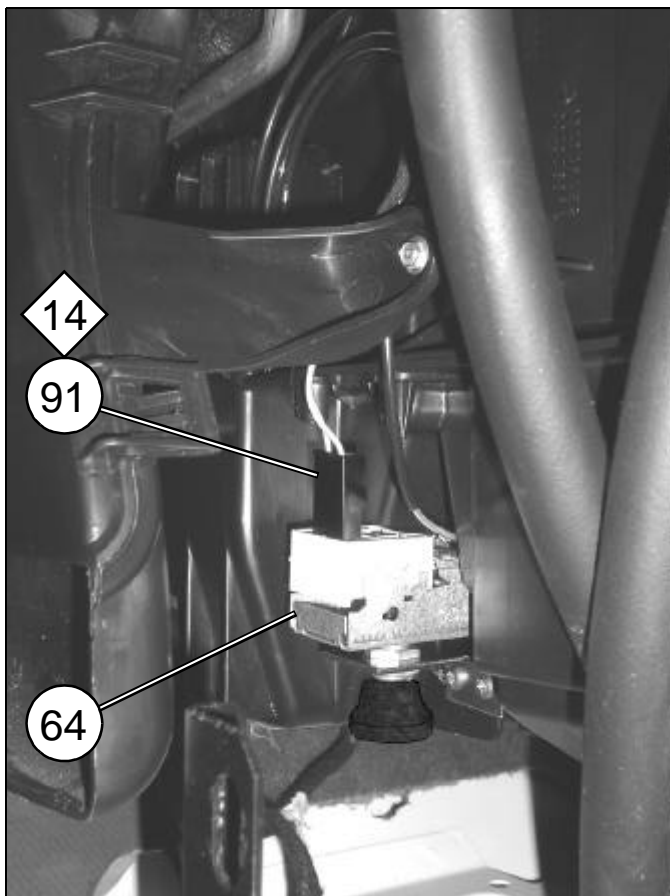

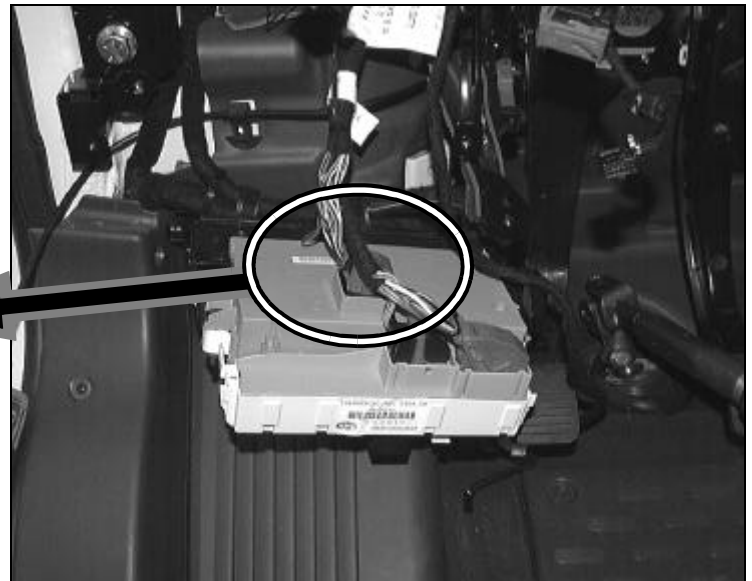
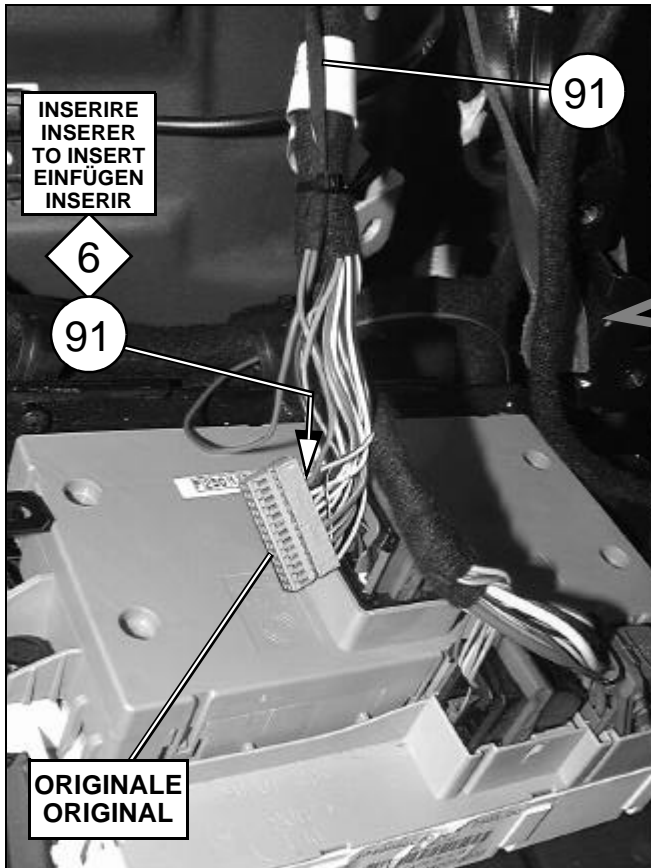

14D

(I)

ATTENZIONE: nel caso in cui nel connettore originale "6" sia presente il cavo originale alla posizione n° 27, collegare il cavo "BLU-VERDE" dell'impianto elettrico "91" mediante giunzione RAYCHEM "93".

(F)

ATTENTION: si dans le connecteur d'origine "6" il y a présence du fil d'origine à la position n° 27, connecter le fil "BLEU-VERT" du faisceau électrique "91" à l'aide du raccord RAYCHEM "93".

(GB)

WARNING: if the original connector "6" has the original wire in position no. 27, hook up the "BLUE-GREEN" wire of the supplied electrical system "91" using the Raychem connector "93".

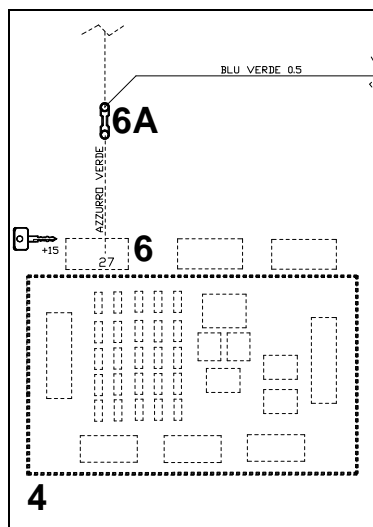
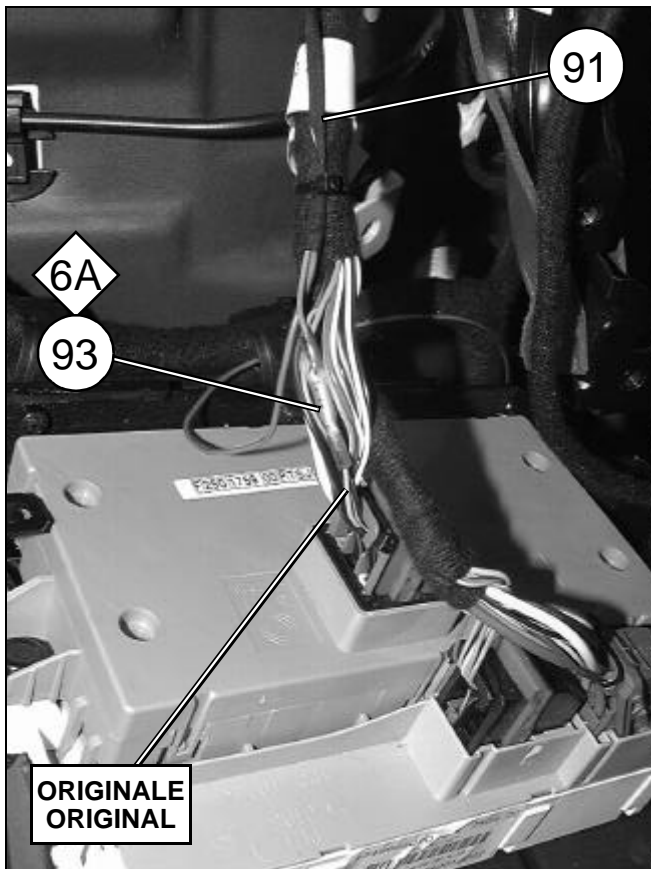

(D)

ACHTUNG: sollte im Original-Steckverbinder "6" das Original-Kabel an Position Nr.27 sich befinden, Kabel "BLAU-GRÜN" der elektrischen Anlage "91" mit Raychem-Verbindung "93" anschließen

(E)

ATENCIÓN: en caso de que en el conector original "6" esté presente el cable original en la posición n° 27, conectar el cable "AZUL-VERDE" de la instalación eléctrica "91" a través de junta RAYCHEM "93".

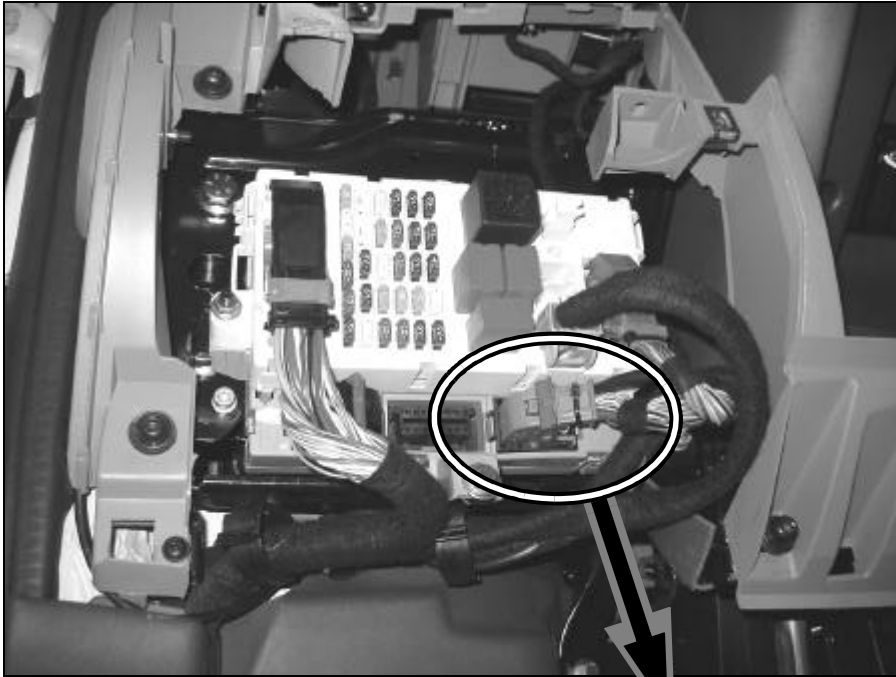

15D

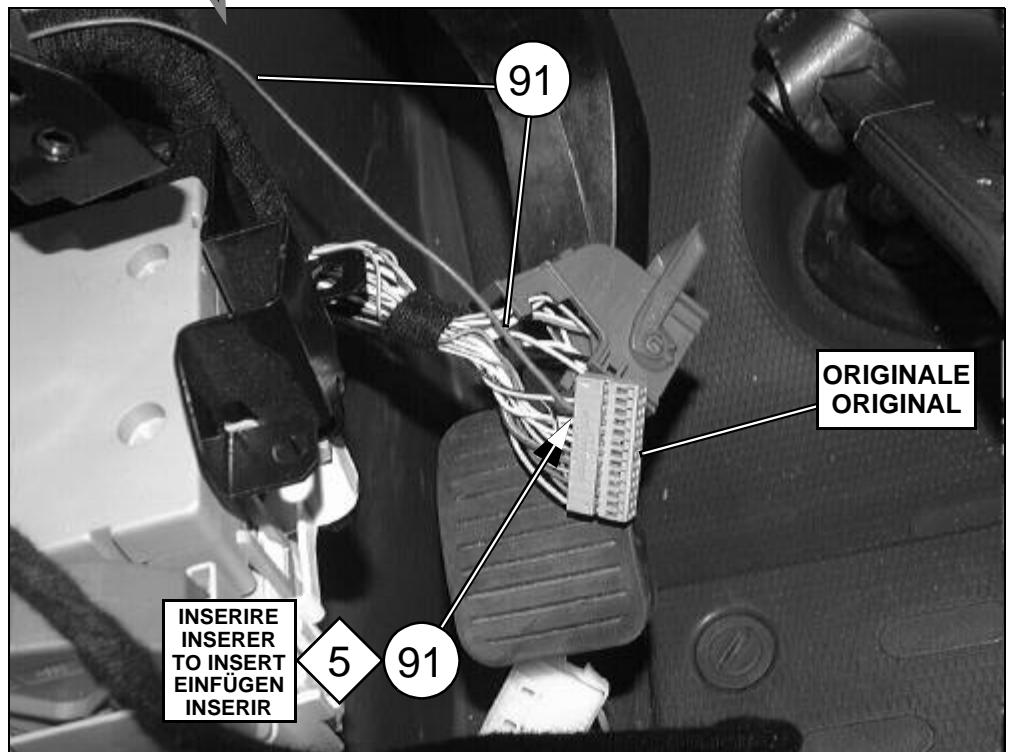

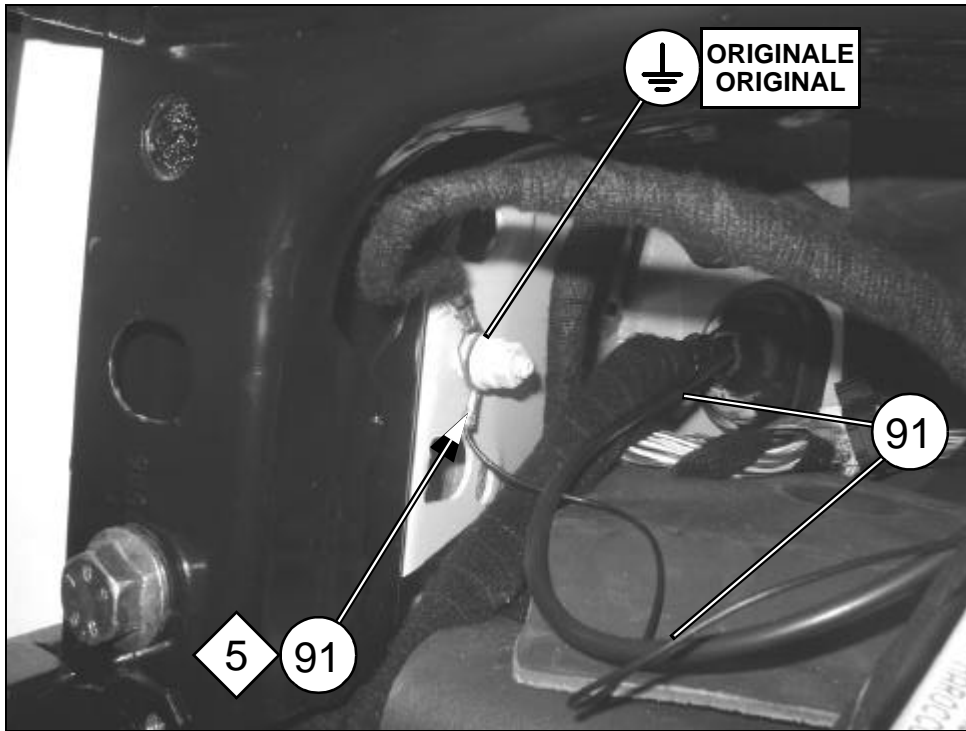

16D

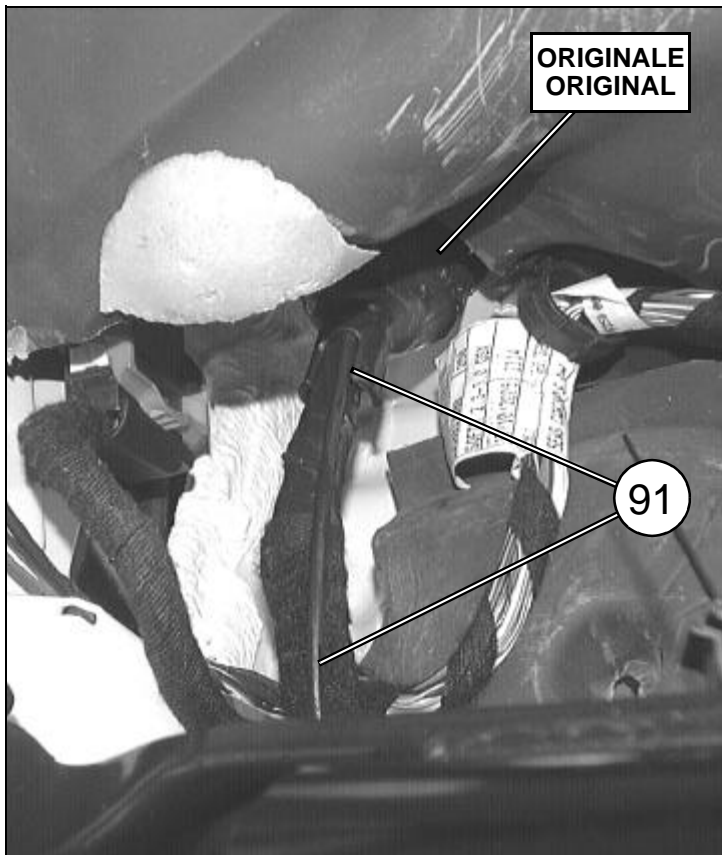

17D

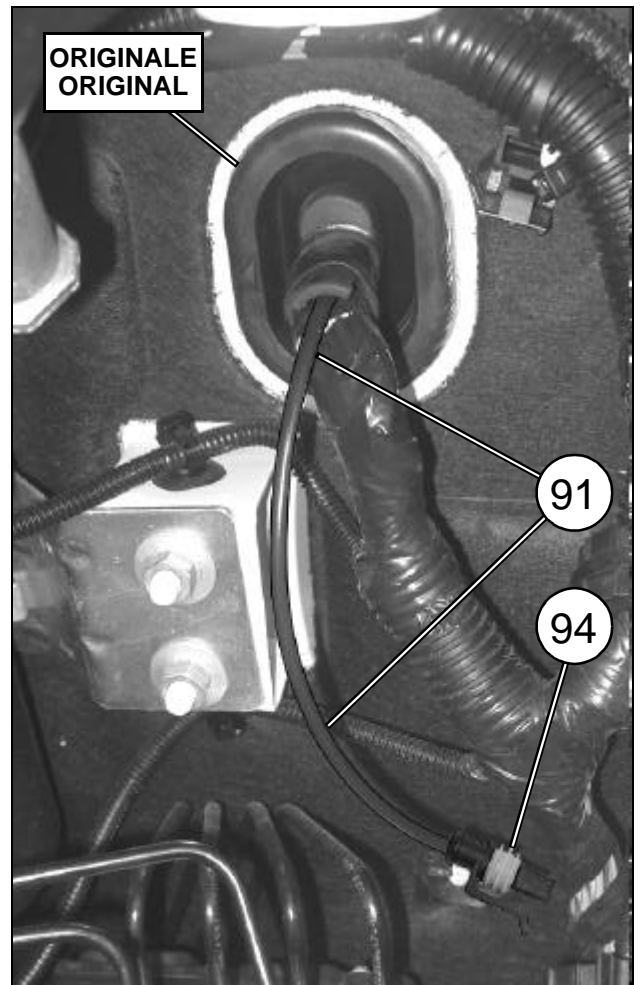

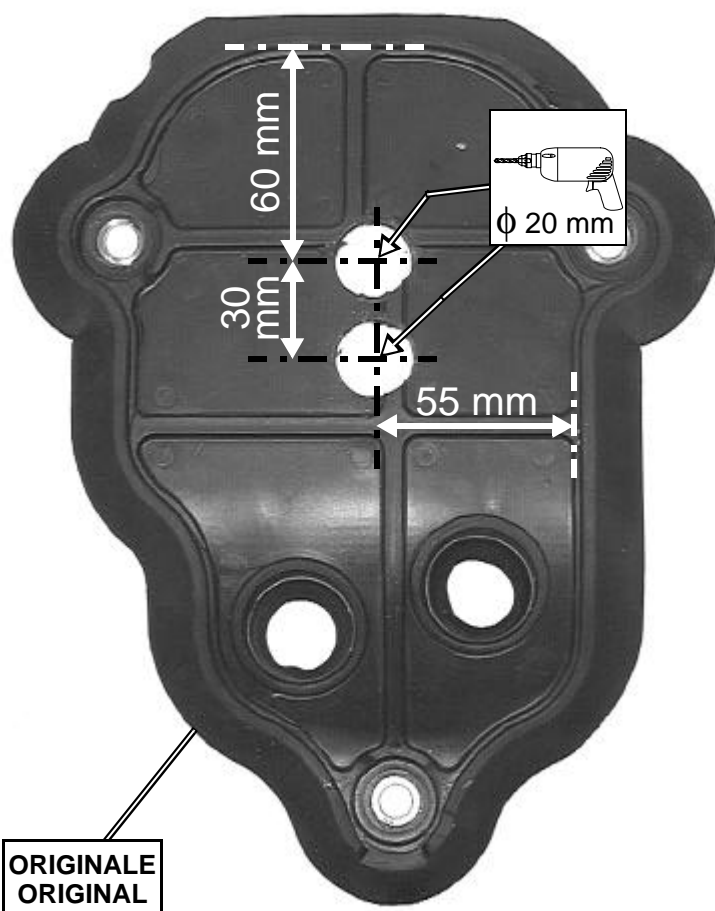

18D

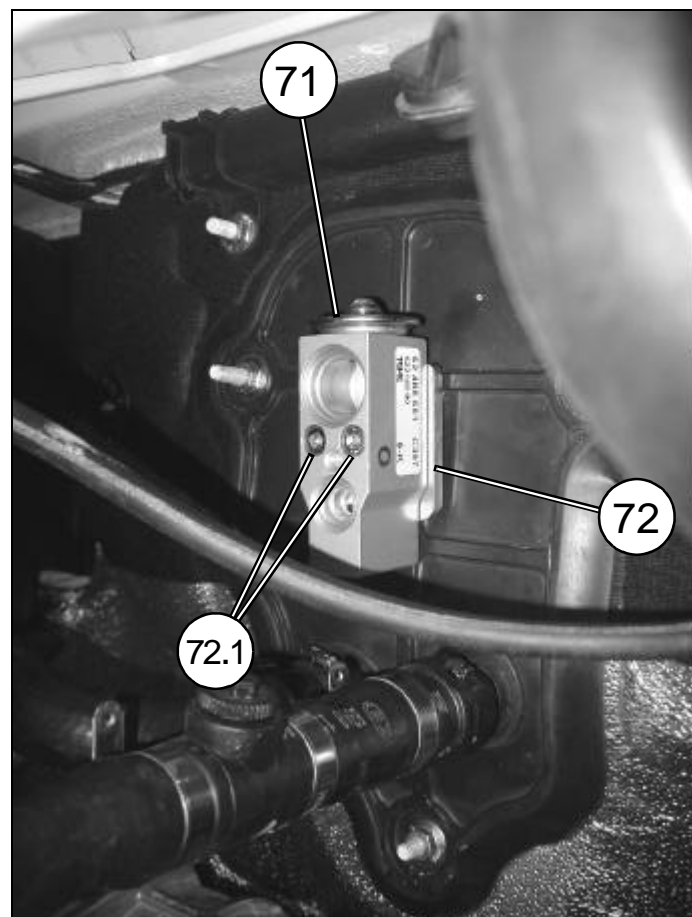
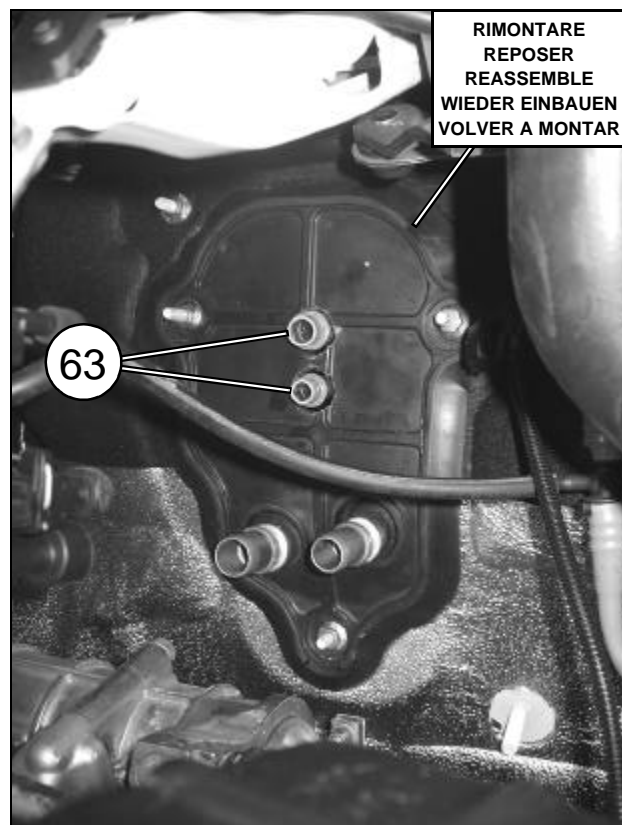

ELEMENTI DI FISSAGGIO / PIECES DE FIXATION FIXING PARTS / BEFESTIGUNGSELEMENTE ELEMENTOS DE FIJACION			
Pos.	Tipologia Typologie Typology Tipologie Tipologia	Descrizione Description Description Beschreibung Descripción	Codice Code Code Codigo
72		Flangia tubi gas	043060/OA
72.1		M5x35	-



19D

- (I)
Rimontare all'interno dell'abitacolo tutti i componenti originali smontati in precedenza.
- (F)
Réposer dans l'habitacle tous les composants d'origine démontés.
- (GB)
Reassemble all the original components in the passenger compartment.
- (D)
Alle vorher ausgebauten Originalbestandteile wieder im Fahrzeuginneren einbauen.
- (E)
Volver a montar en el interior del habitáculo todos los componentes originales desmontados anteriormente.

**COLLEGAMENTO TUBI GAS-INSTALLAZIONE COMPONENTI ELETTRICI NEL VANO MOTORE
 RACCORDEMENT DES TUYAUX GAZ-INSTALLATION COMPOSANTS ELECTRIQUES DANS LE COMPARTIMENT MOTEUR
 GAS PIPE CONNECTION-INSTALLATION OF ELECTRICAL COMPONENTS IN THE ENGINE COMPARTMENT
 KAEITEMITTELSCHLAUCHVERBINDUNG-INSTALLATION DER ELEKTRISCHEN TEILE IM MOTORRAUM
 CONEXION TUBOS GAS-INSTALACION COMPONENTES ELECTRICOS EN EL COMPARTIMENTO MOTOR**

MATERIALE FORNITO / MATERIEL FOURNI / SUPPLIED MATERIAL / GELIEFERTES MATERIAL / MATERIAL ABASTECIDO

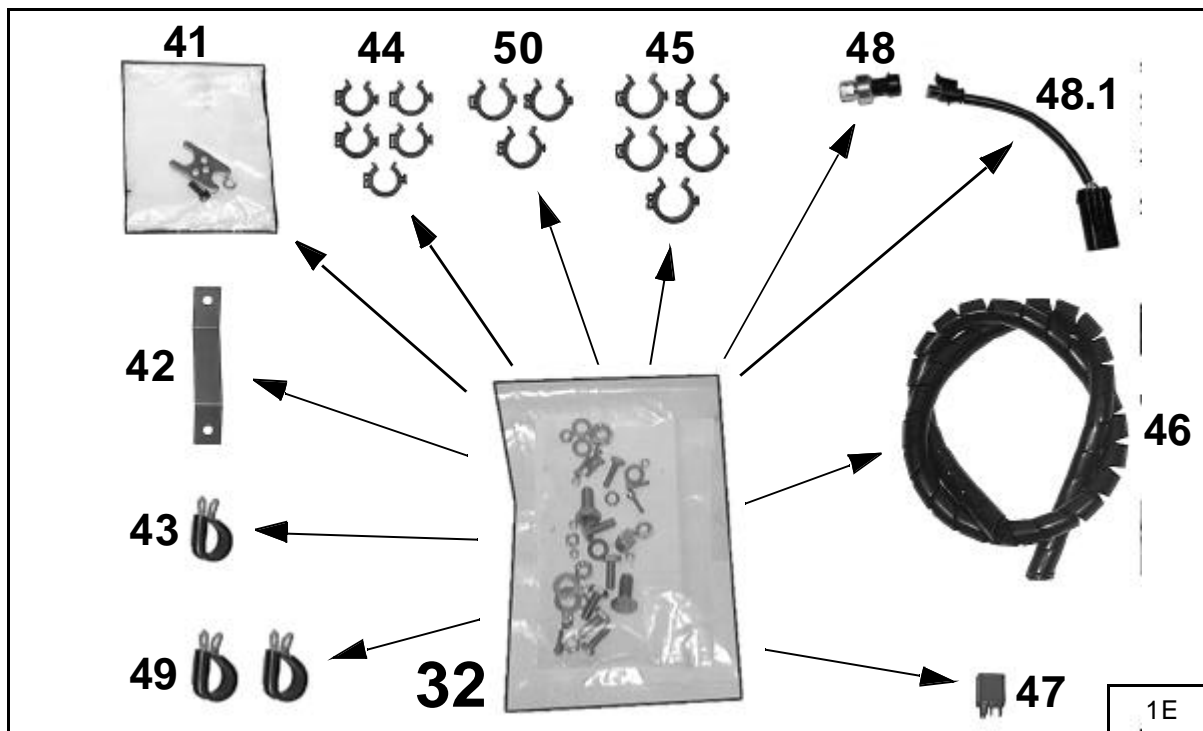

Pos.	Descrizione / Description / Description / Beschreibung / Descripción	Codice / Code Code / Codice
32	Sacchetto accessori	0231886/0
41	Sacchetto flangia	043066/1A
42	Staffa di supporto tubi gas	0361820/0
43	Fascetta in gomma	069032/0
44	Fermatubo ϕ 18	069635/0
45	Fermatubo ϕ 24	069637/0
46	Protezione a spirale	070494/0
47	Relay interruttore	0681911/0
48	Trasduttore di pressione	043358/0
48.1	Cablaggio per trasduttore di pressione	0682863/0
49	Fascetta in gomma	069033/0A
50	Fermatubo ϕ 22	069636/0

TUBI GAS / TUYAUX GAZ / GAS PIPE / KAEITEMITTELSCHLÄUCHE / TUBOS GAS	
Descrizione / Description / Description / Beschreibung / Descripción	Codice / Code Code / Codice
Tubo gas 5/16"CF (condensatore-filtro)	806E184
Tubo gas 5/16"FE (filtro-evaporatore)	806E185/1
Tubo gas 13/32"CC (compressore-condensatore)	808E216/1
Tubo gas 1/2"EC (evaporatore-compressore)	810E217

MATERIALE FORNITO / MATERIEL FOURNI / SUPPLIED MATERIAL / GELIEFERTES MATERIAL / MATERIAL ABASTECIDO

0282457/3

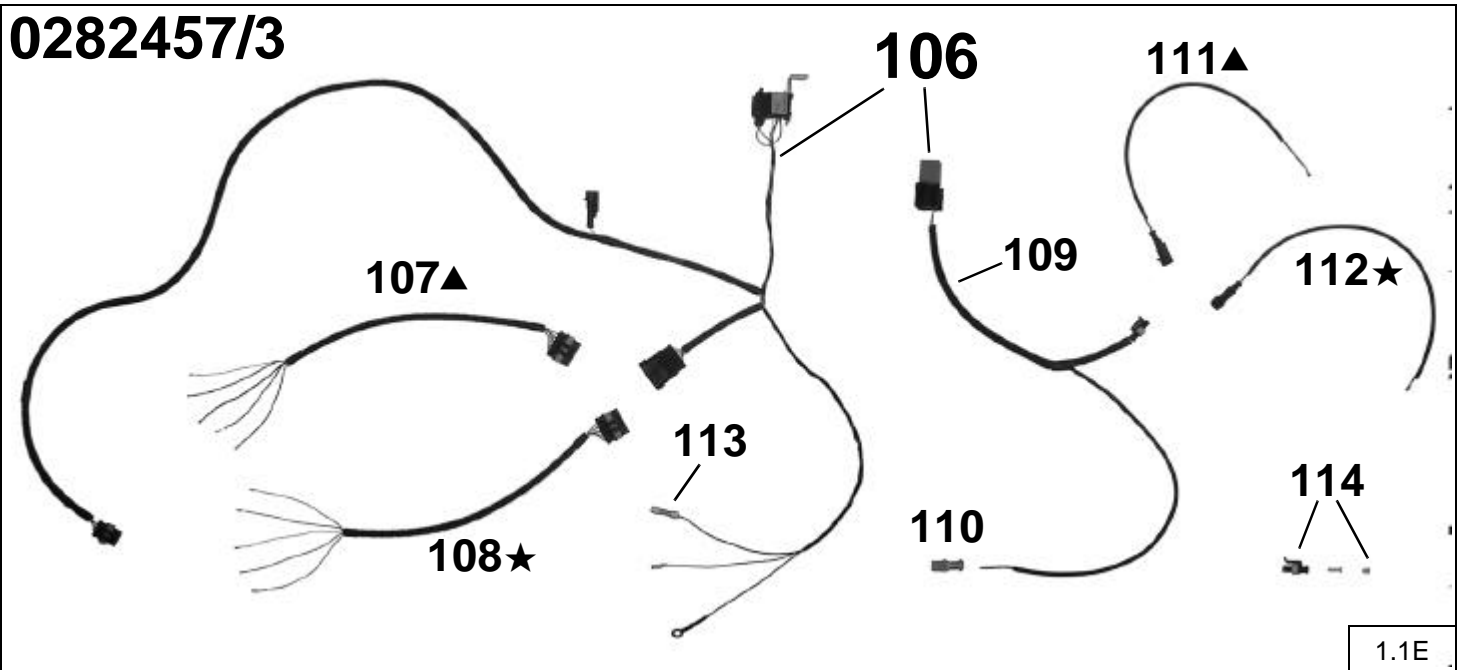

Pos.	Descrizione / Description Description / Beschreibung Descripción	Codice / Code Kode / Código
106	Impianto elettrico elettroventole	0282457/3
107▲	Cablaggio per centralina elettronica	-
108★	Cablaggio per centralina elettronica	-
109	Cablaggio supplementare	-
110	Terminale	-
111▲	Cablaggio per centralina elettronica	-
112★	Cablaggio per centralina elettronica	-
113	Giunzione RAYCHEM ROSSA	064274/0
114	Connettore PACKARD 1 via	-
▲	<i>Valido per veicoli con motore 2.2 / Valable pour véhicules avec moteur 2.2 Valid for vehicles with engine 2.2 / Gültig für Fahrzeuge mit Motor 2.2 Valido para coches con motor 2.2</i>	
★	<i>Valido per veicoli con motore 2.3 - 3.0 / Valable pour véhicules avec moteur 2.3 - 3.0 Valid for vehicles with engine 2.3 - 3.0 / Gültig für Fahrzeuge mit Motor 2.3 - 3.0 Valido para coches con motor 2.3 - 3.0</i>	

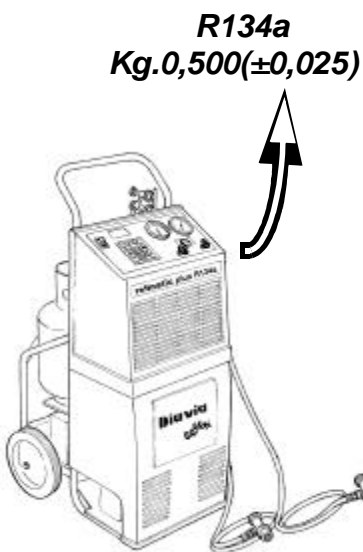
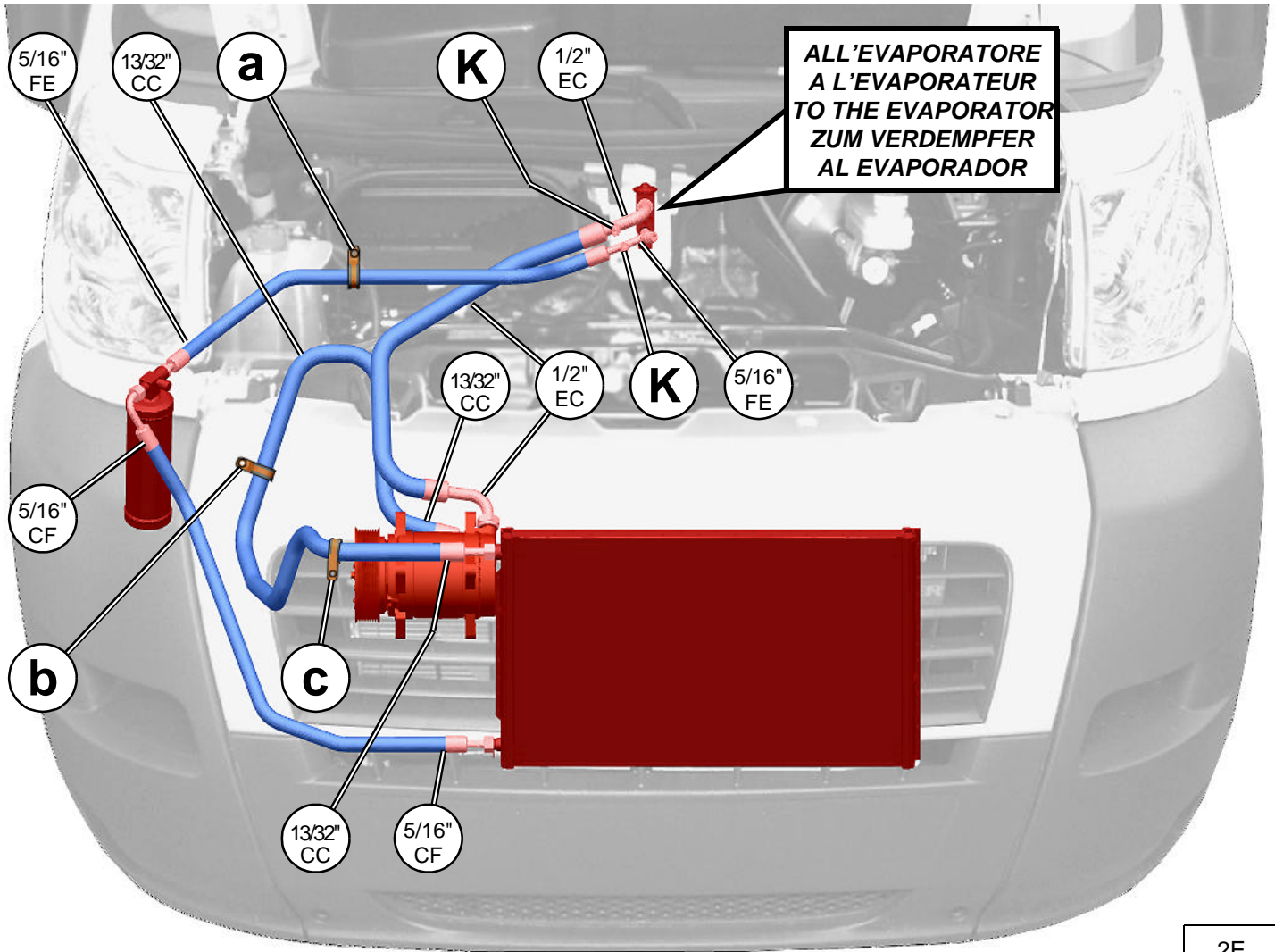

(I)
Vista complessiva passaggio tubi gas nel vano motore.

Alle posizioni "a-b-c" sono evidenziati i punti di fissaggio tubi alla vettura, descritti in particolare nelle figure che seguono. Alle posizioni "K" sono evidenziate le valvole di carica dell'impianto aria condizionata predisposte sui raccordi tubi gas 1/2"EC e 5/16"FE.

(F)
Vue d'ensemble du passage des tuyaux gaz dans le compartiment moteur.

Les points de fixation des tuyaux à la voiture, décrits en détail sur les figures qui suivent, sont mis en évidence aux positions "a-b-c". Aux pos. "K" on a indiqué les soupapes de charge équipement A/C prévues sur les raccords des tuyaux gaz 1/2"EC et 5/16"FE.

(GB)
General view of the gas hoses in the engine compartment.

Positions "a-b-c" indicate the points for securing pipes to the vehicle, described in detail in the following figures. At the position "K", the A/C system charge valves prepared on the 1/2"EC and 5/16"FE gas hoses couplings are shown.

(D)
Gesamtansicht des Durchgangs der Kältemittelschläuche im Motorraum.

Bei den Positionen "a-b-c" sind die Befestigungspunkte der Schläuche am Fahrzeug hervorgehoben. An den Positionen "K" sind die Füllventile der Klimaanlage an den Anschlüssen der 1/2"EC und 5/16"FE-Kältemittelschläuchen hervorgehoben.

(E)
Vista total paso tubos gas en el compartimiento motor.

En las posición "a-b-c" se evidencian los puntos de sujeción de los tubos al coche, descritos detalladamente en las figuras que siguen. En las posiciones "K" están evidenciadas las válvulas de carga de la instalación aire acondicionado preparados en los racord tubos gas 1/2"EC y 5/16"FE.

3E

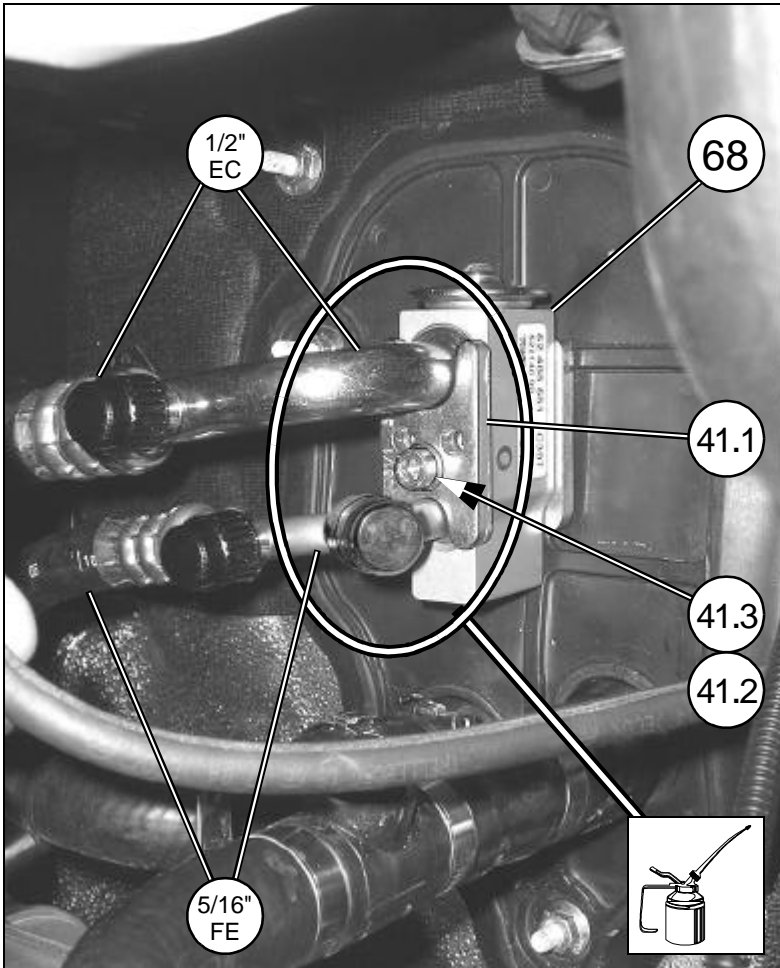

ELEMENTI DI FISSAGGIO / PIECES DE FIXATION FIXING PARTS / BEFESTIGUNGSELEMENTE ELEMENTOS DE FIJACION			
Pos.	Tipologia Typologie Typology Tipologie Tipologia	Descrizione Description Description Beschreibung Descripción	Codice Code Code Codigo
41.1		Flangia tubi gas	043061/1A
41.2		M6x16	-
41.3		φ6	-

4E

ELEMENTI DI FISSAGGIO / PIECES DE FIXATION FIXING PARTS / BEFESTIGUNGSELEMENTE ELEMENTOS DE FIJACION		
Pos.	Tipologia / Typologie Typology / Tipologie Tipologia	Descrizione / Description Description / Beschreibung Descripción
42.1		M6x20
42.2		φ6
42.3		M6

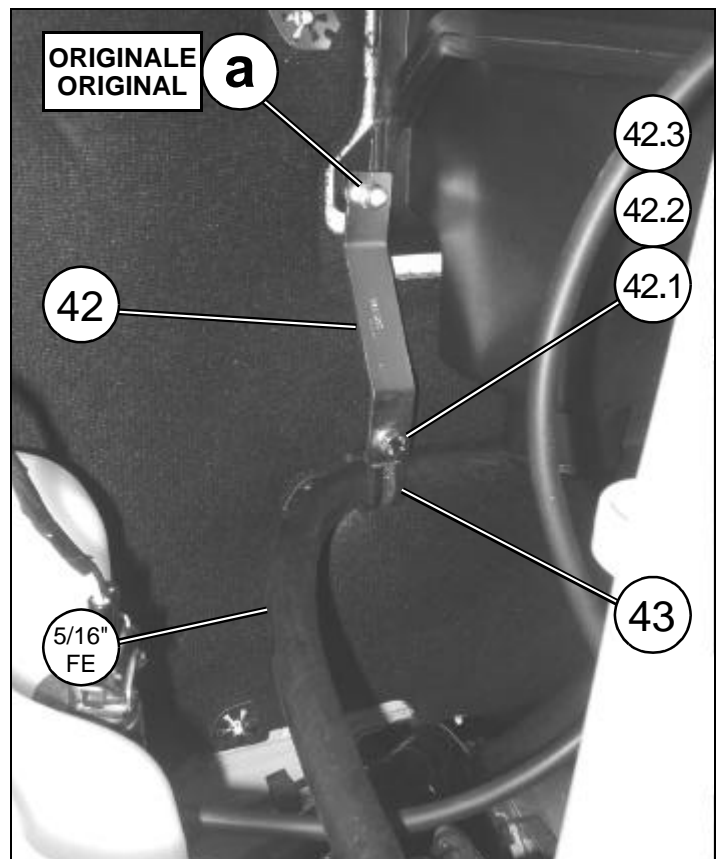

ELIMINARE
ELIMINER
DISCARD
ENTFERNEN
ELIMINAR

ORIGINALE
ORIGINAL

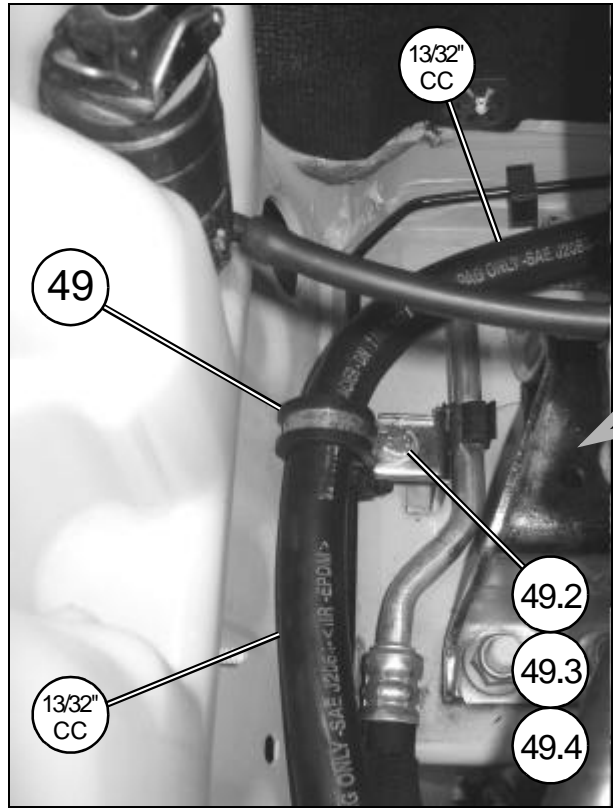
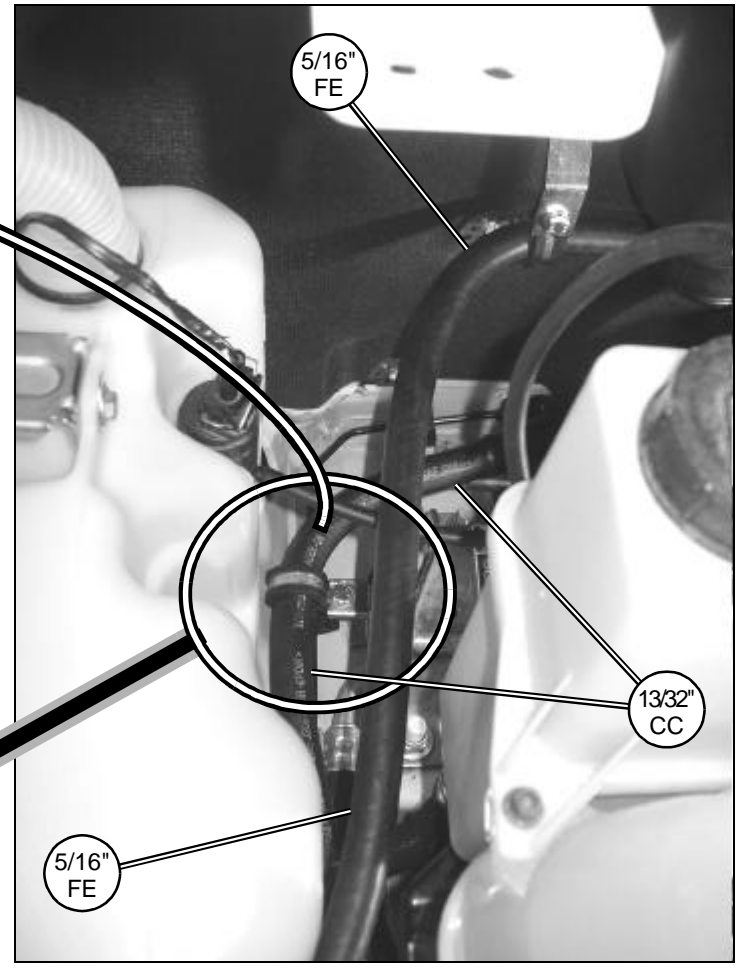
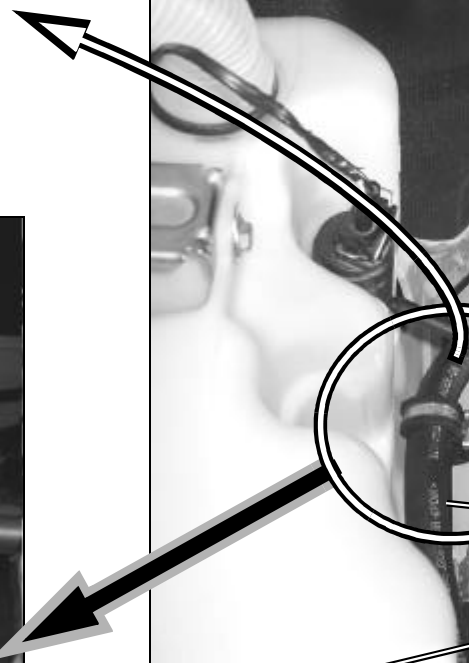

5E

ELEMENTI DI FISSAGGIO / PIECES DE FIXATION FIXING PARTS / BEFESTIGUNGSELEMENTE ELEMENTOS DE FIJACION		
Pos.	Tipologia / Typologie Typology / Tipologie Tipologia	Descrizione / Description Description / Beschreibung Descripción
49.2		M6x20
49.3		φ6
49.4		M6

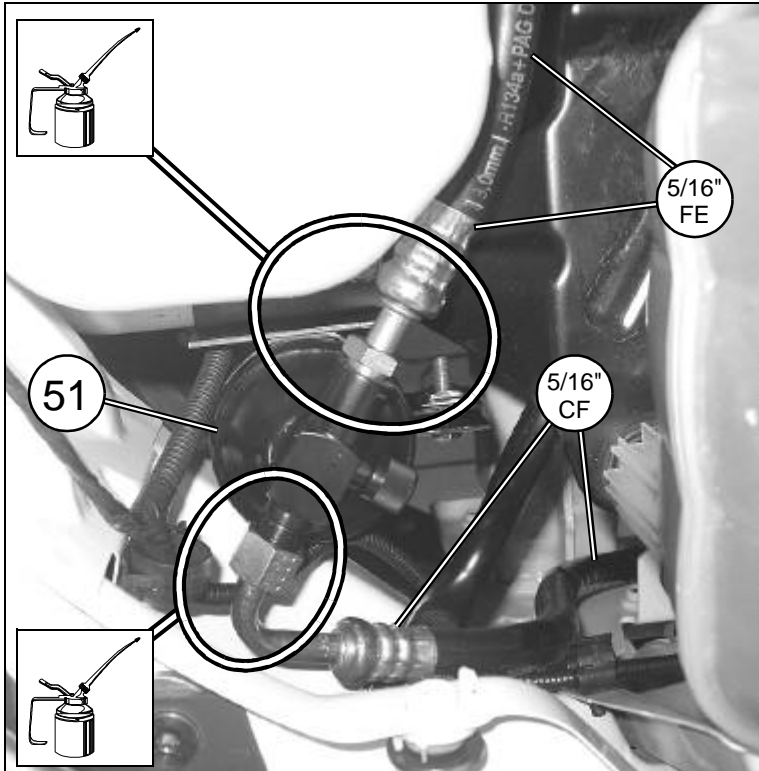

6E

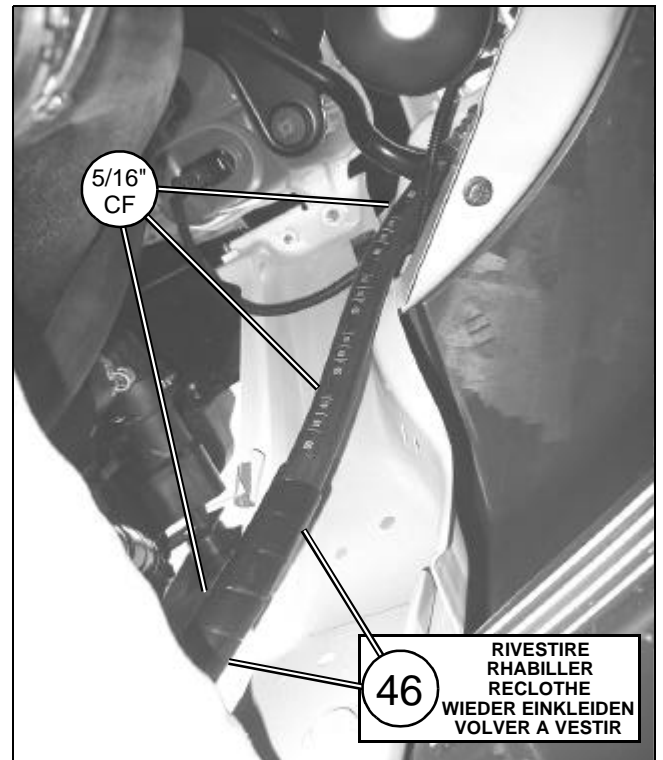

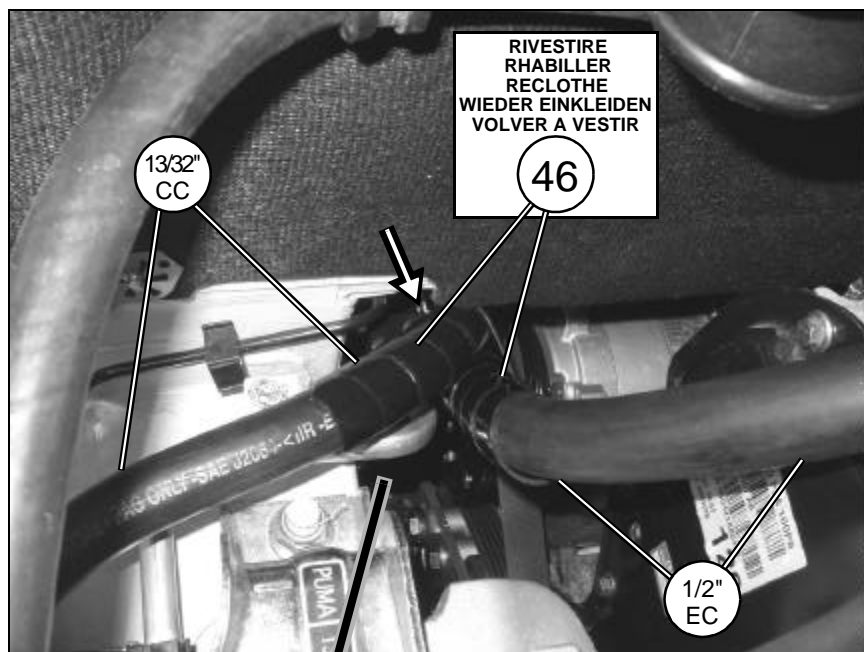

7E



ELIMINARE
ELIMINER
DISCARD
ENTFERNEN
ELIMINAR

**ORIGINALE
ORIGINAL**

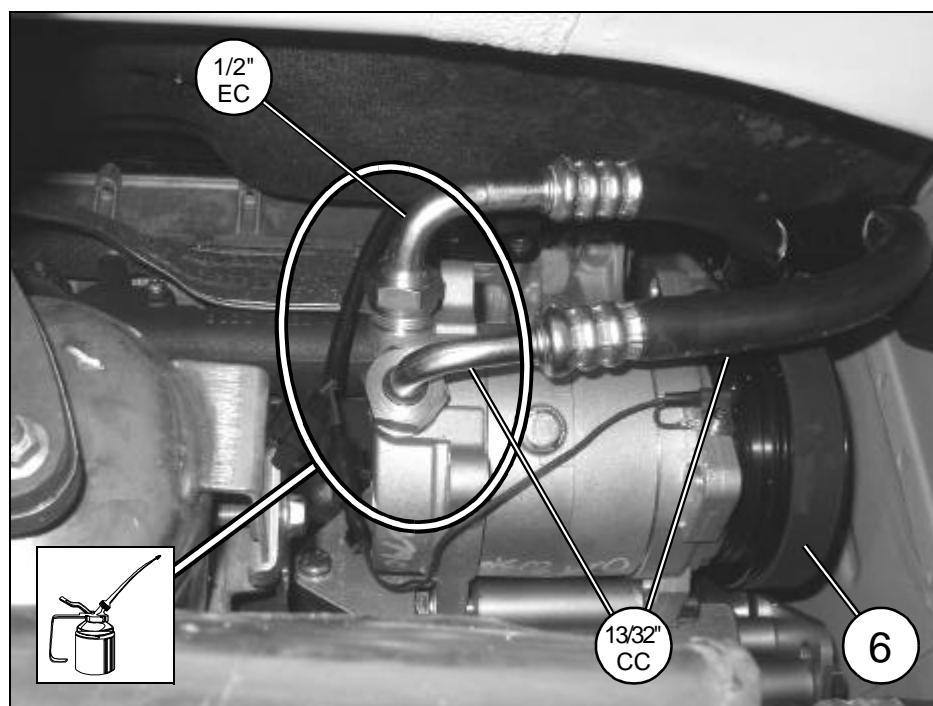

ELEMENTI DI FISSAGGIO / PIECES DE FIXATION FIXING PARTS / BEFESTIGUNGSELEMENTE ELEMENTOS DE FIJACION		
Pos.	Tipologia / Typologie Typology / Tipologie Tipologia	Descrizione / Description Description / Beschreibung Descripción
		Fascetta a strappo

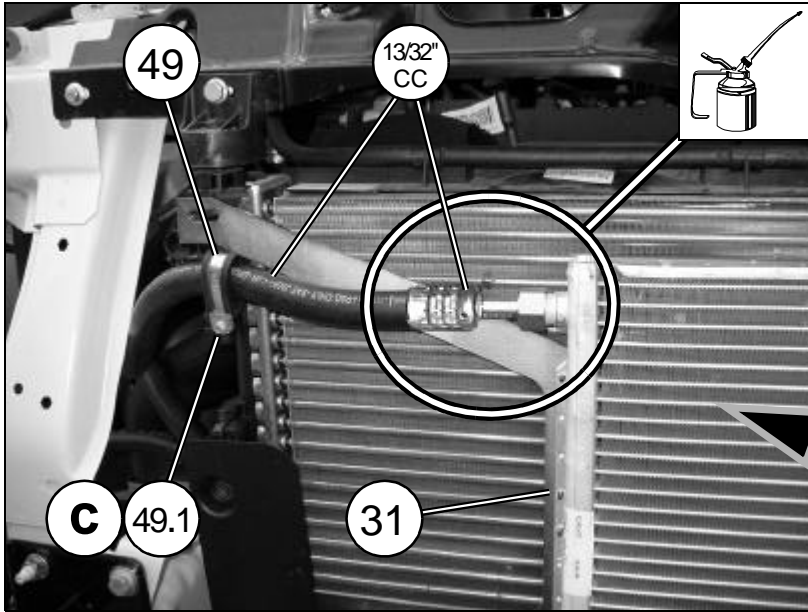

7E

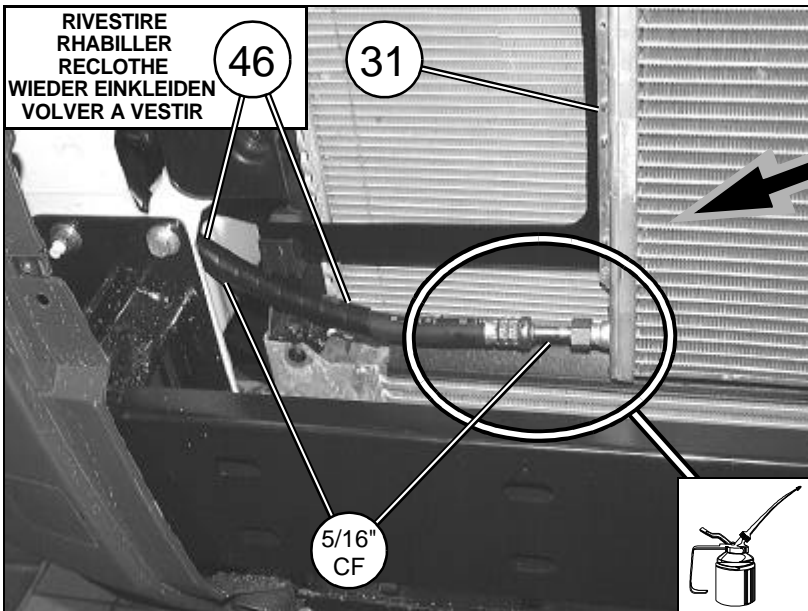
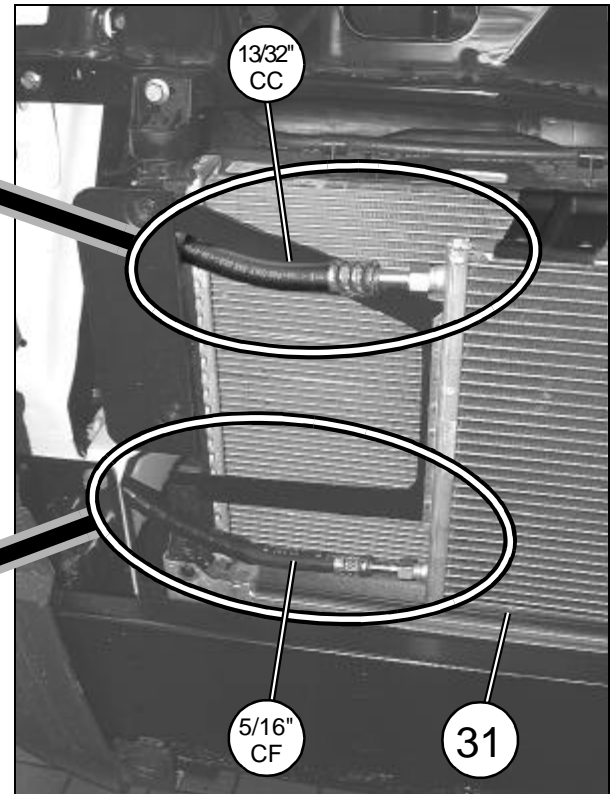

ELEMENTI DI FISSAGGIO / PIECES DE FIXATION FIXING PARTS / BEFESTIGUNGSELEMENTE ELEMENTOS DE FIJACION		
Pos.	Tipologia / Typologie Typology / Tipologie Tipologia	Descrizione / Description Description / Beschreibung Descripción
49.1		4.2x16

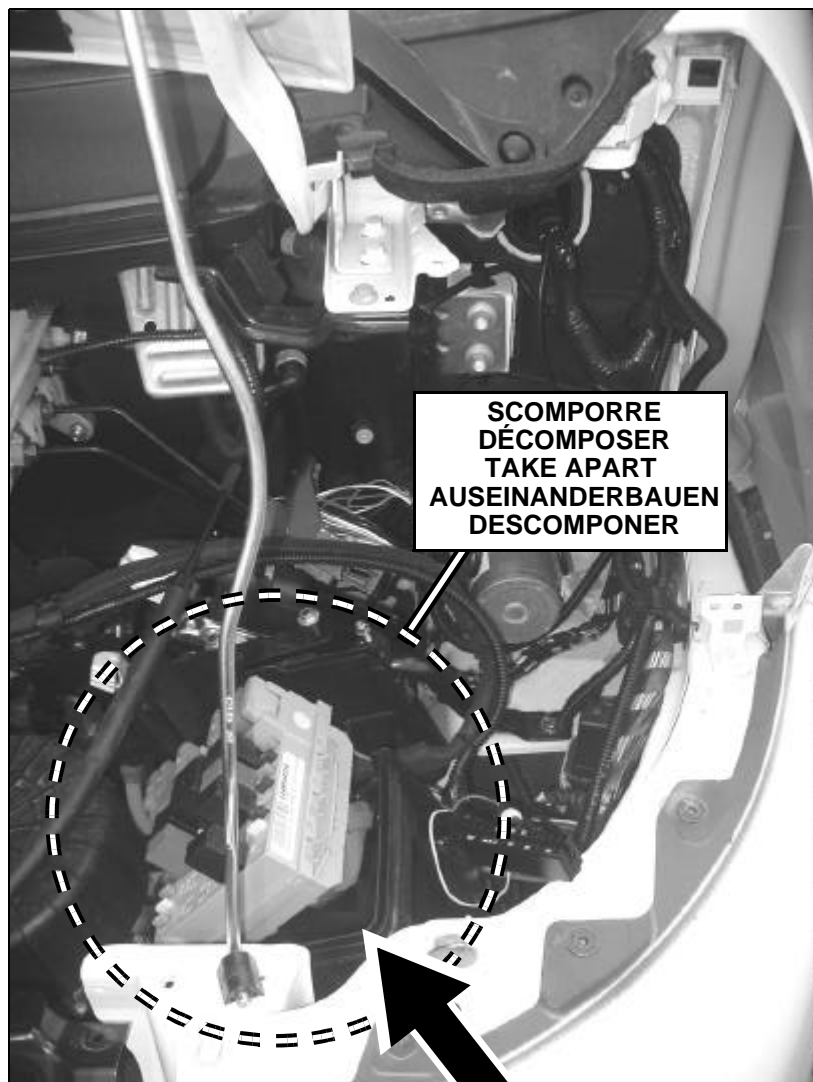

SCOMPORRE
 DÉCOMPOSER
 TAKE APART
 AUSEINANDERBAUEN
 DESCOMPONER

**ELEMENTI DI FISSAGGIO / PIECES DE FIXATION
 FIXING PARTS / BEFESTIGUNGSELEMENTE
 ELEMENTOS DE FIJACION**

Pos.	Tipologia Typologie Typology Tipologie Tipologia	Descrizione Description Description Beschreibung Descripción
106.1		5,5x12

8E

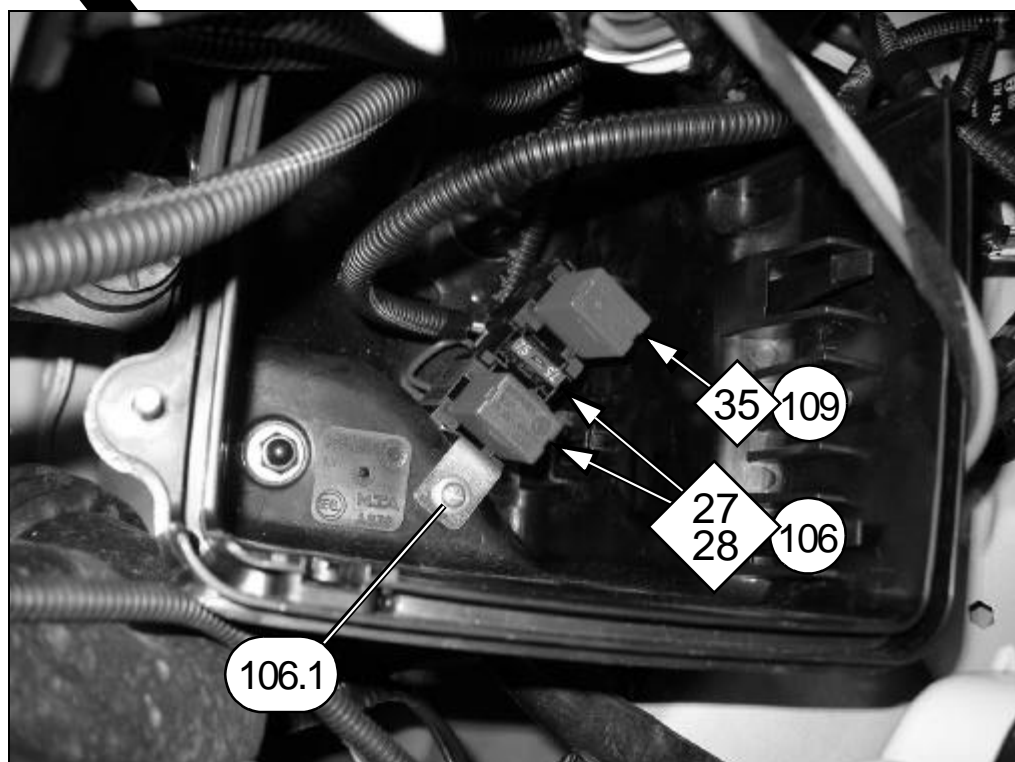

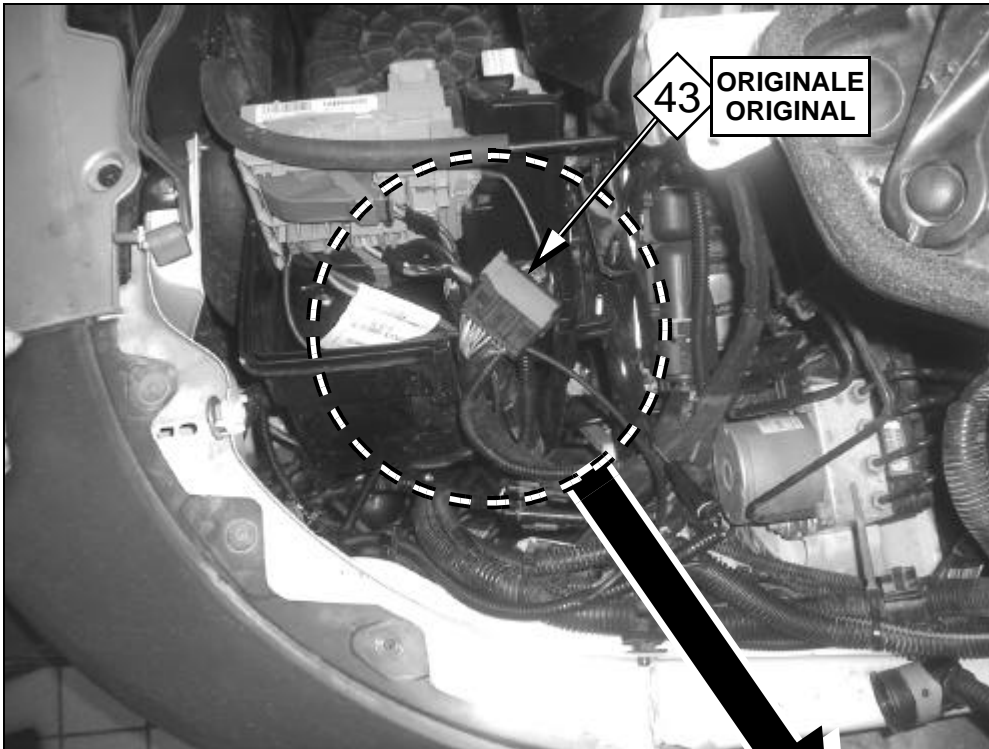

9E



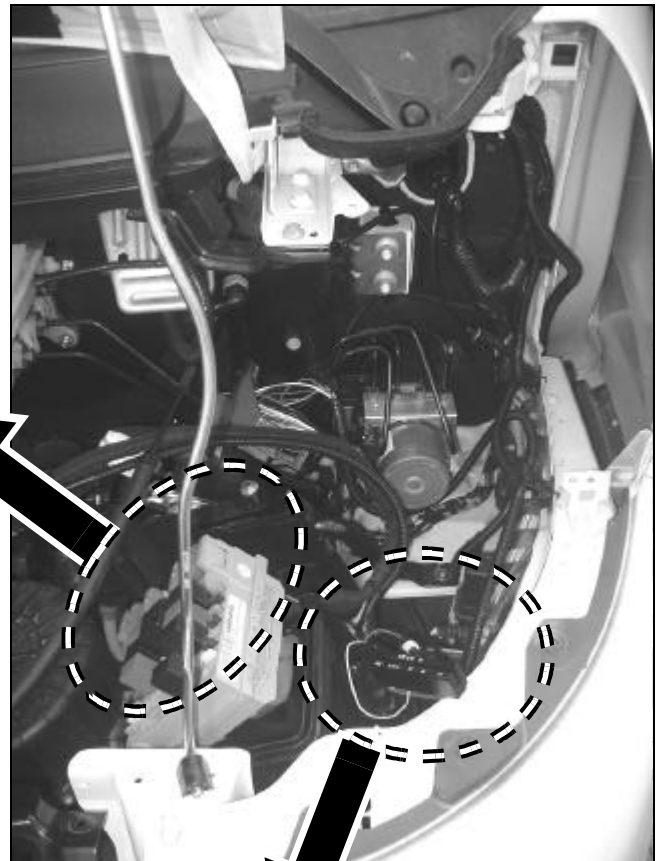
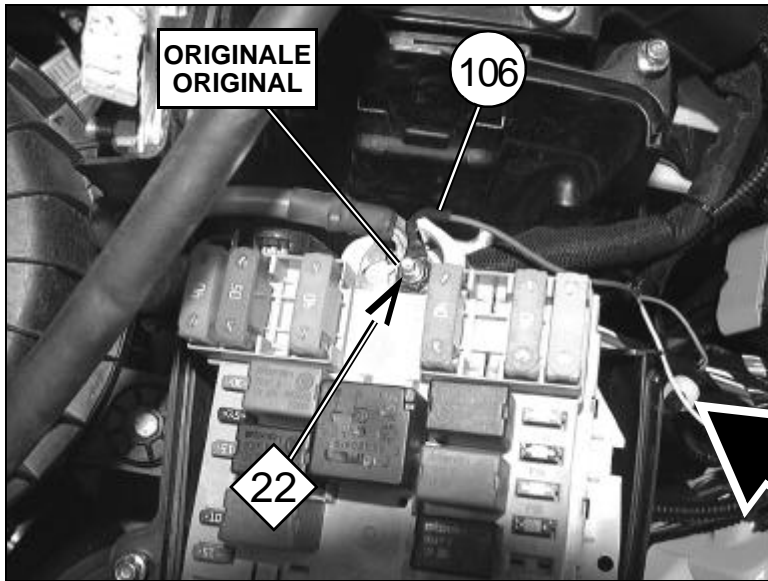

10E

SMONTARE
DEMONTER
REMOVE
AUSBAUEN
DESMONTAR

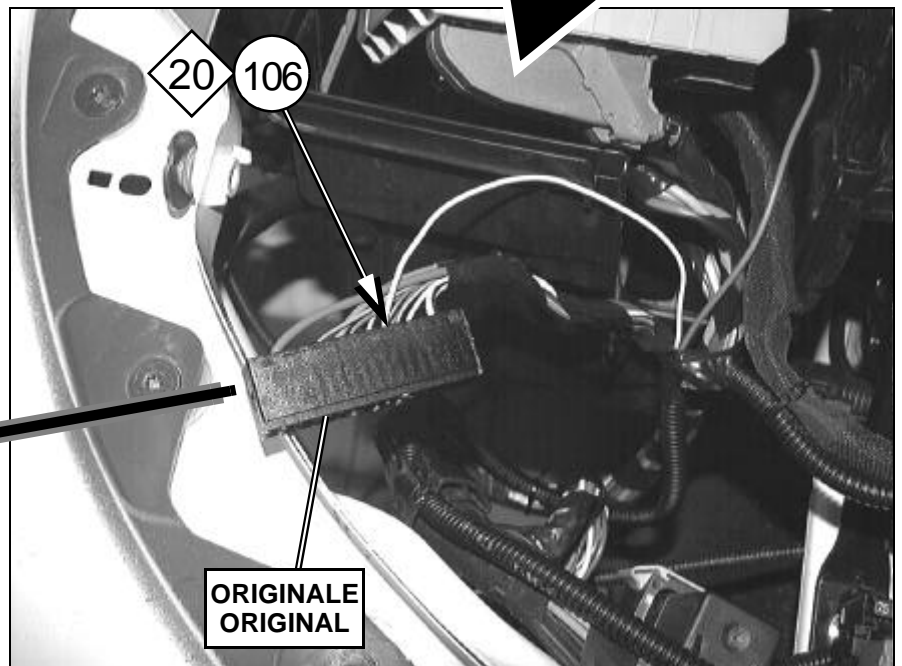

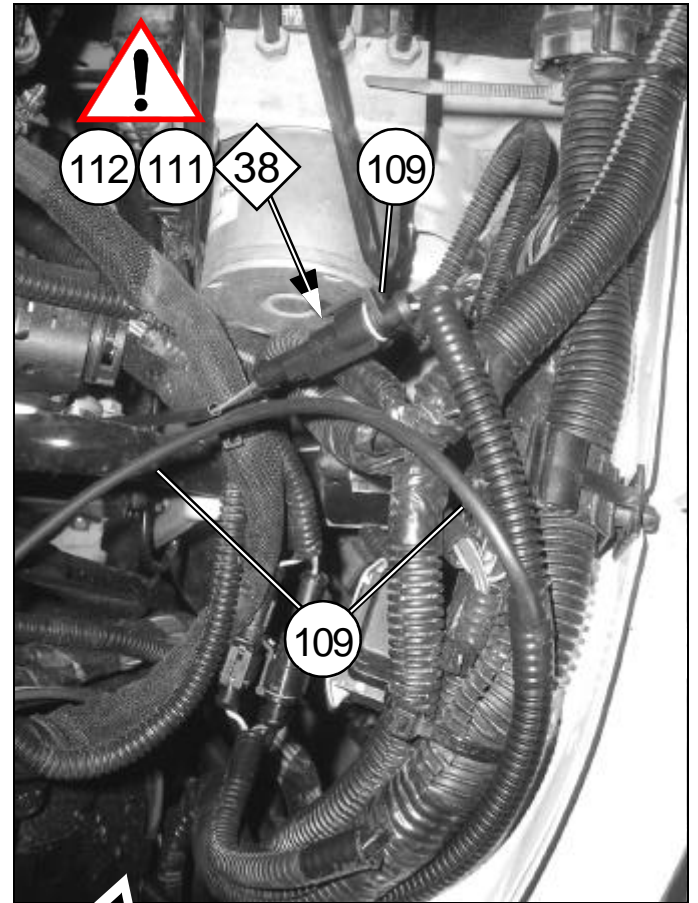
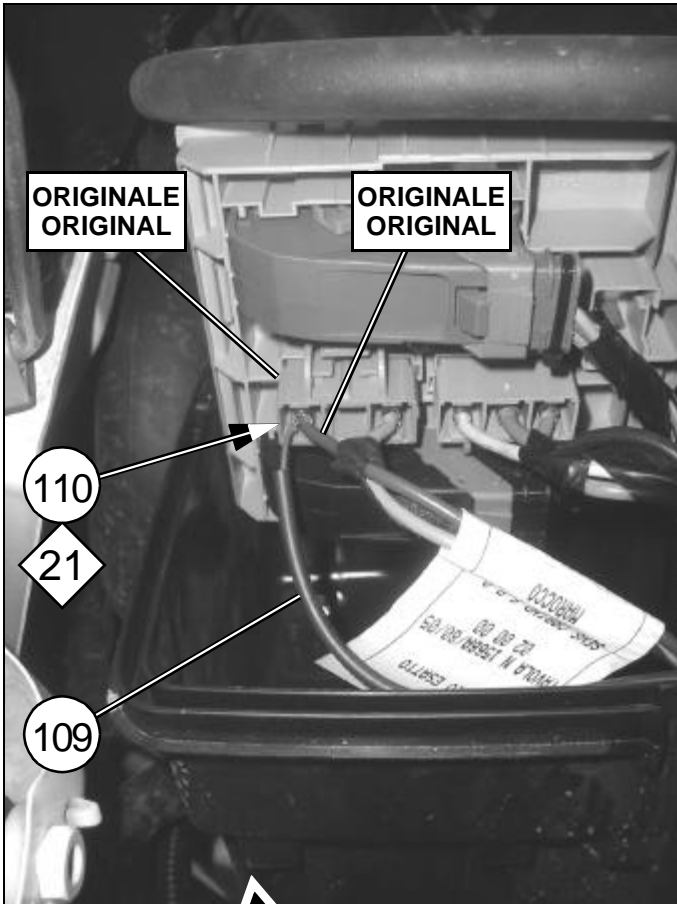

VEDI ANCHE FIGURA SEGUENTE
VOIR AUSSI LA FIGURE SUIVANTE
ALSO SEE THE FOLLOWING FIGURE
SIEHE AUCH FOLGENDE ABBILDUNG
VÉASE TAMBIÉN FIGURA SIGUIENTE

11E

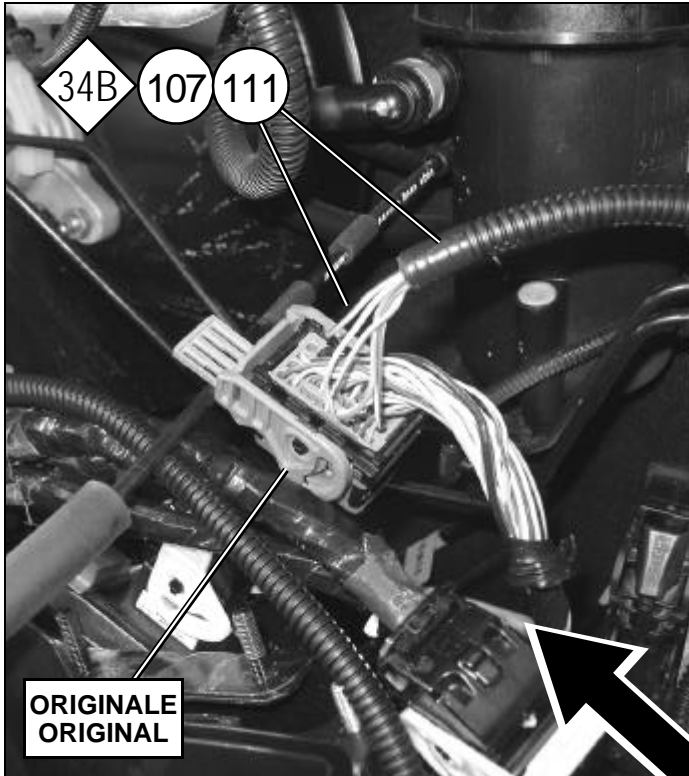

12E

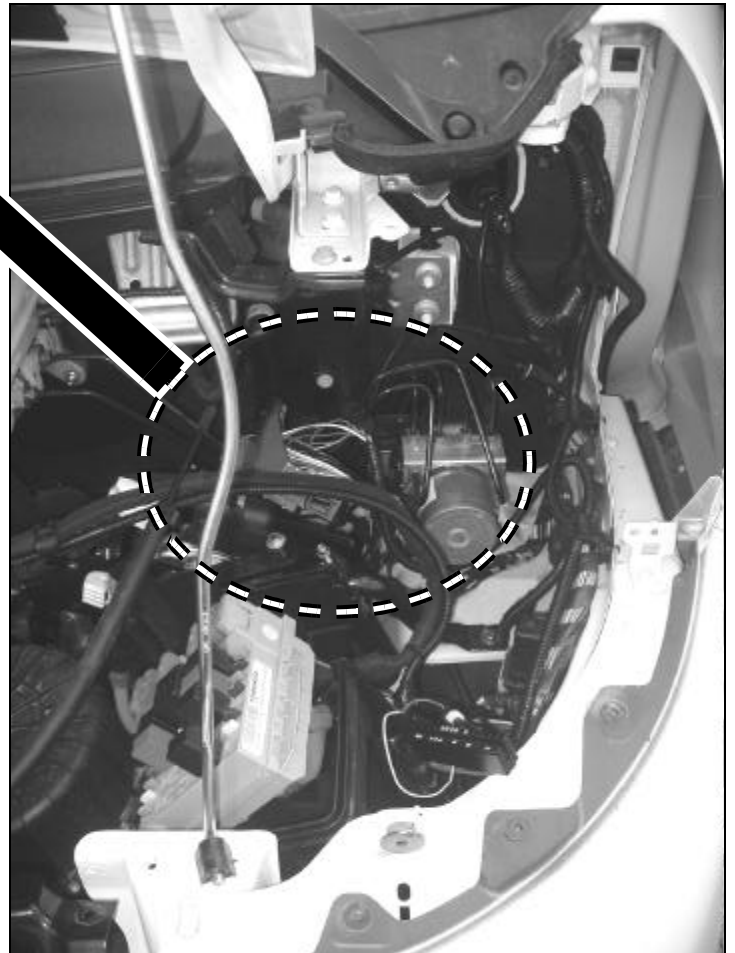

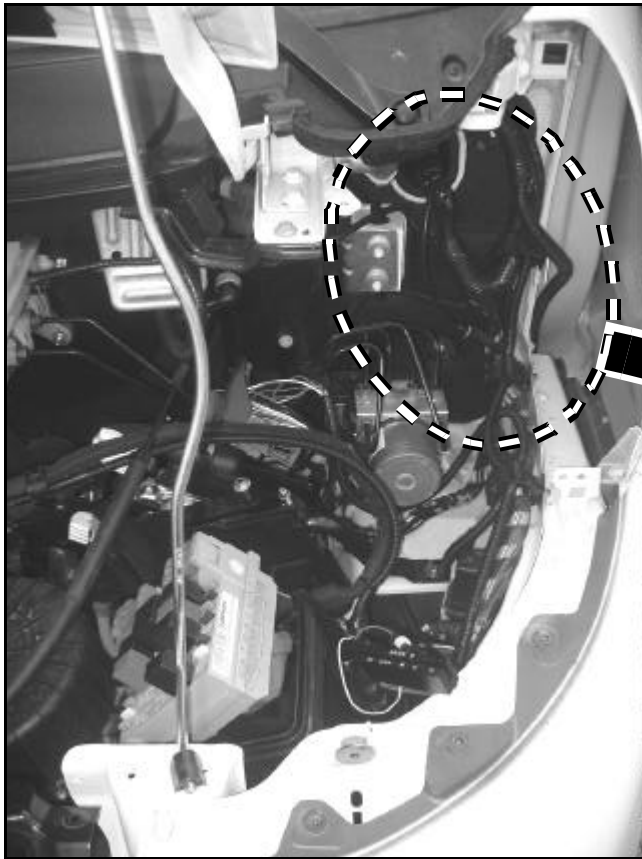

13E

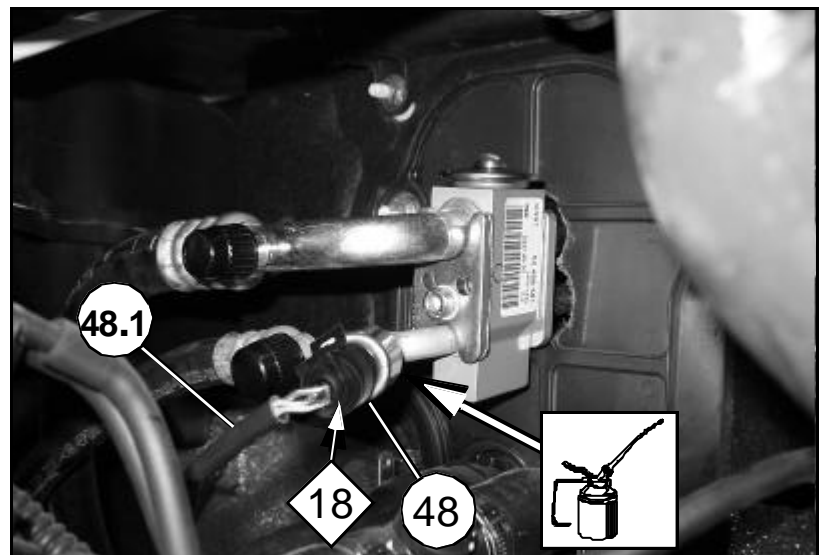
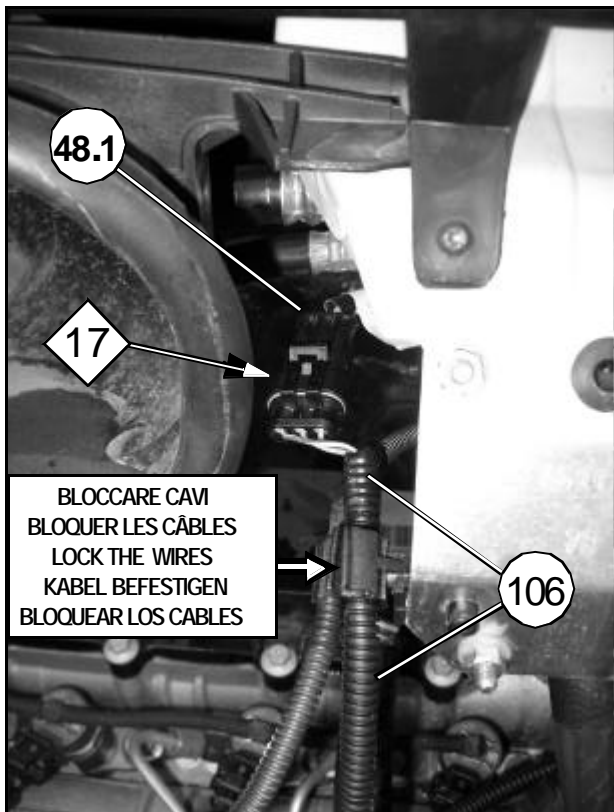
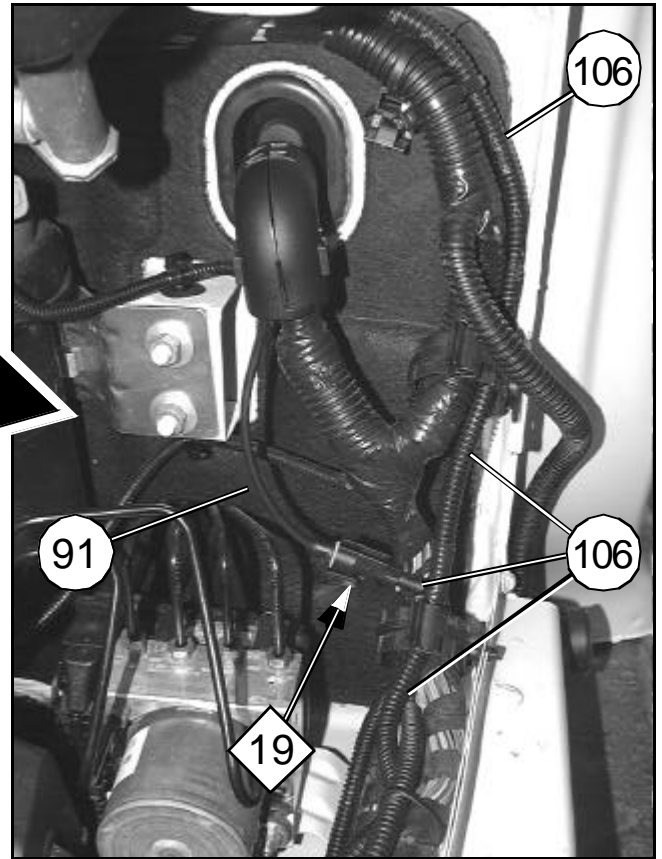

14E

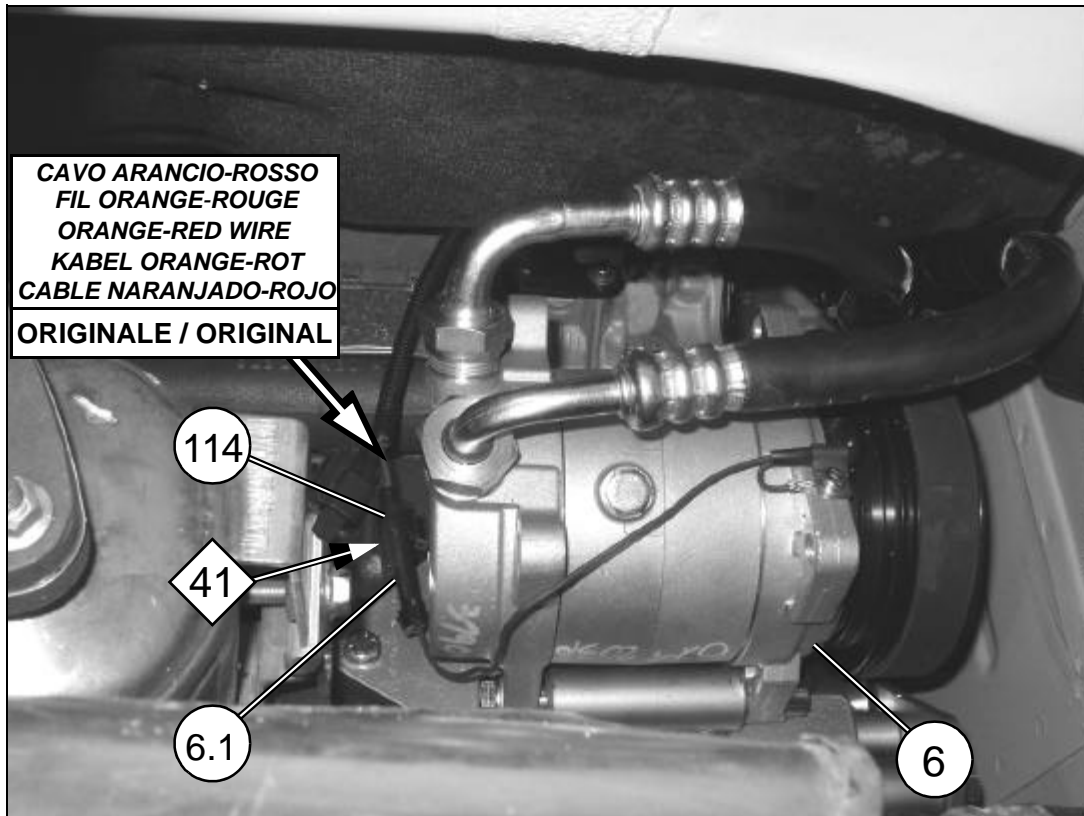

15E

SCHEMA IMPIANTO ELETTRICO / SCHEMA DE L'INSTALLATION ELECTRIQUE / WIRING DIAGRAM
SCHEMA DER ELEKTRISCHEN ANLAGE / ESQUEMA INSTALACION ELECTRICA
DUCATO 2.2 MJT - SERIE X250 / JUMPER-BOXER 2.2 HDi

27/08/09

0282457/3

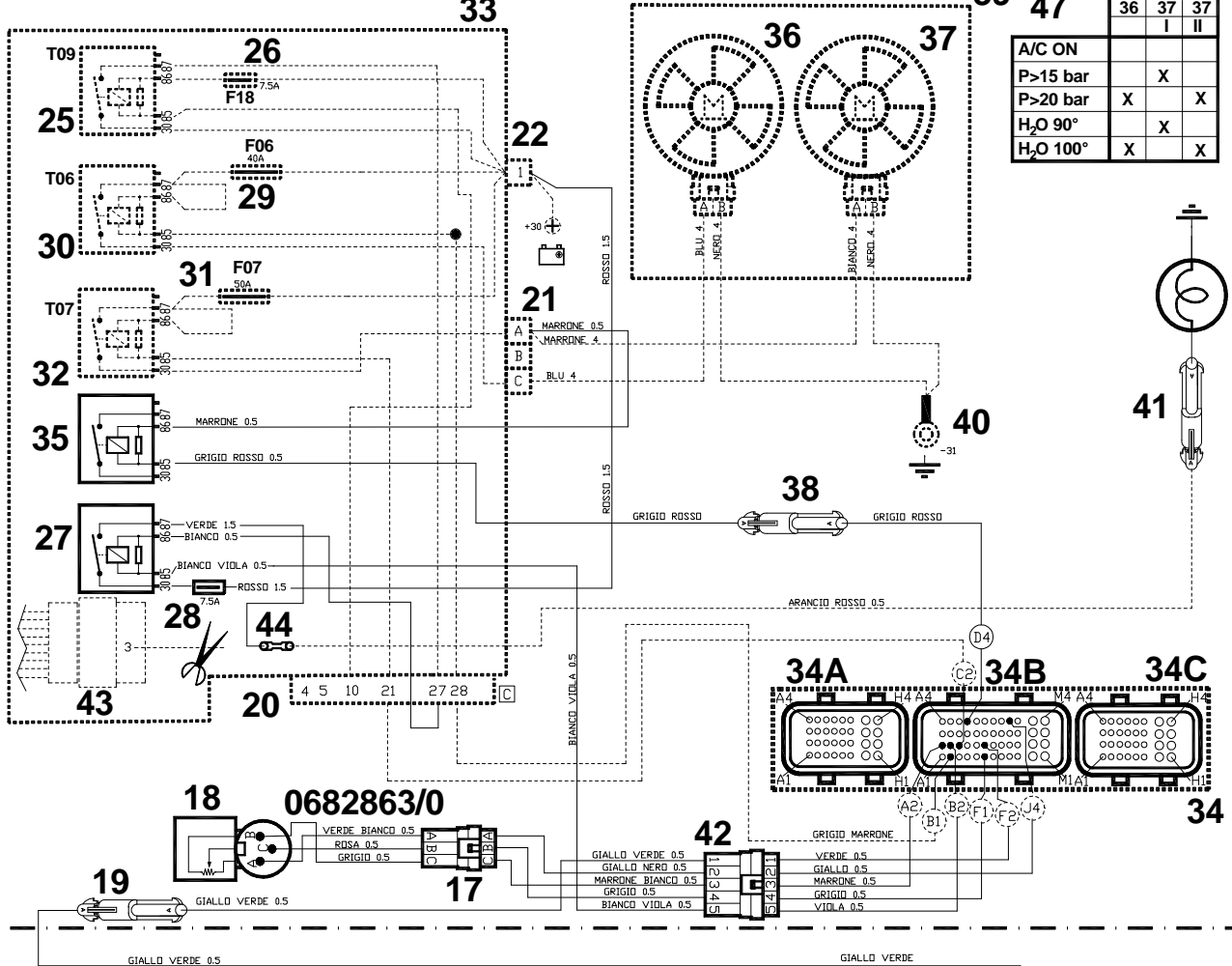

0282453/0

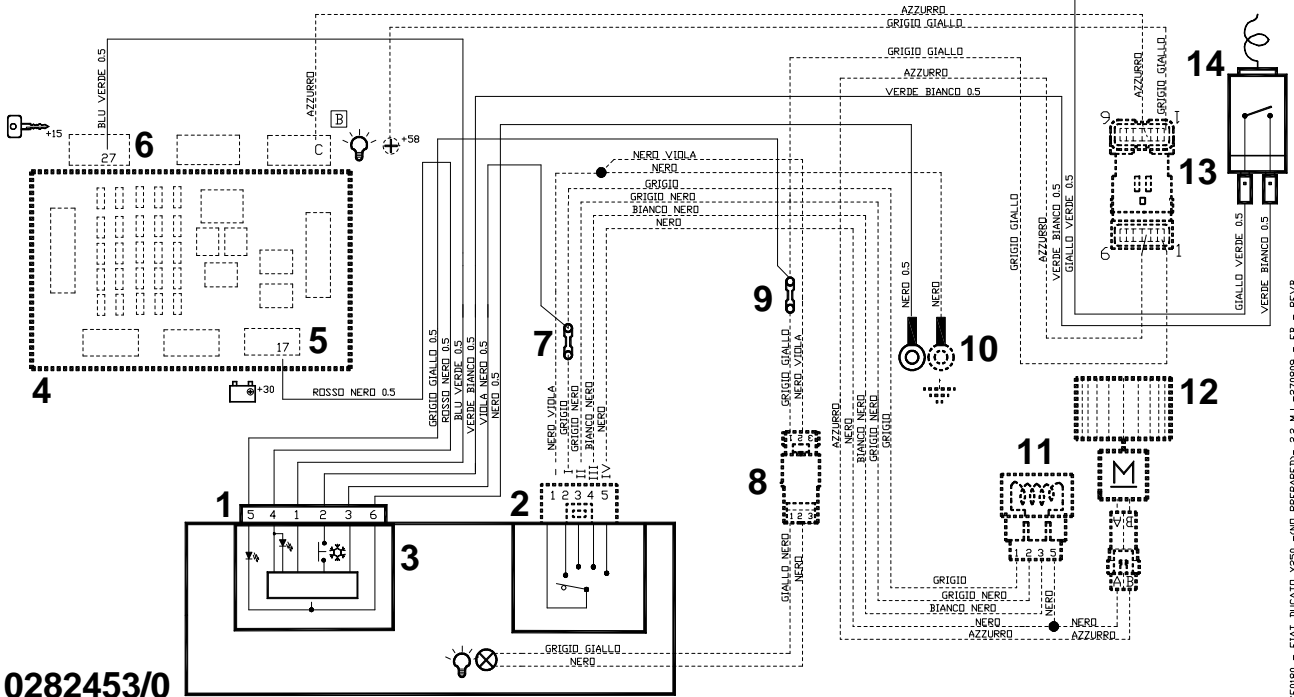

SEC0880 - FIAT DUCATO X250 - (NO PREPARED) - 2.2 MJ - 270809 - EB - REV B

N.	Descrizione / Description / Description Beschreibung / Descripción	Funzione / Fonction / Function Funktion / Función
1	Connettore 6 vie Connecteur à 6 voies 6-way connector 6-weg-Steckverbinder Conector 6 vía	
2	Connettore 5 vie Connecteur à 5 voies 5-way connector 5-weg-Steckverbinder Conector 5 vía	
3	Interruttore di comando A.C. Interrupteur de commande A.C. A.C. control switch Klimaanlagenschalter Interruptor de comando A.C	
4	Scatola porta relay Boîte à relais Relay box Relaiskasten Caja porta-realais	
5	Connettore 52 vie Connecteur à 52 voies 52-way connector 52-weg-Steckverbinder Conector 52 vía	
6	Connettore 36 vie Connecteur à 36 voies 36-way connector 36-weg-Steckverbinder Conector 36 vía	
7	Giunzione RAYCHEM BLU Raccord RAYCHEM BLEU BLUE RAYCHEM connector RAYCHEM Verbindung BLAU Junta RAYCHEM TURQUI	Collegamento con 1° velocità di ventilazione Connexion avec 1° vitesse de ventilation Connection to the 1st fan speed Anschluß mit der 1. Lüftungsgeschwindigkeit Conexión con 1° velocidad ventilación
8	Connettore 3 vie Connecteur à 3 voies 3-way connector 3-weg-Steckverbinder Conector 3 vía	
9	Giunzione RAYCHEM ROSSO Raccord RAYCHEM ROUGE RED RAYCHEM connector RAYCHEM Verbindung ROT Junta RAYCHEM ROJO	Collegamento con +LUCI (+58) Connexion aux BLOCS OPTIQUES (+58) Connection to the LIGHTS (+58) Anschluß mit +LICHT (+58) Conexión con +LUCES (+58)
10	Terminale ad occhio Borne en boutonnière Ring terminal Ösenstecker Terminal a ojillo	Collegamento con MASSA (-31) Connexion à la MASSE (-31) Connection to GROUND (-31) Anschluß mit Masse (-31) Conexión con MASA (-31)
11	Resistore / Résistance / Resistor Widerstand / Resistor	
12	Elettroventola abitacolo Pulseur de l'habitacle Passenger compartment air blower Elektrolüfter im Fahrzeuginnenraum Electroventilador del habitáculo	
13	Connettore 6 vie Connecteur à 6 voies 6-way connector 6-weg-Steckverbinder Conector 6 vía	
14	Termostato / Thermostat / Thermostat Thermostat / Termostato	

17	Connettore 3 vie Connecteur à 3 voies 3-way connector 3-weg-Steckverbinder Conector 3 vías	
18	Trasduttore di pressione Capteur de pression Pressure transducer Druckwandler Transductor de presión	
19	Connettore 1 via Connecteur à 1voie 1-way connector 1-weg-Steckverbinder Conector 1 vía	Collegamento esterno-interno vettura Connexion extérieure-intérieure de la voiture Inner-outer car connection Verbindung mit Fahrzeugäußeren und -innerem Conexión exterior-interior coche
20	Connettore 32 vie (NERO) Connecteur à 32 voies (NOIR) 32-way connector (BLACK) 32-weg-Steckverbinder (SCHWARZ) Conector 32 vías (NEGRO)	
21	Connettore 3 vie Connecteur à 3 voies 3-way connector 3-weg-Steckverbinder Conector 3 vías	
22	Punto di derivazione batteria Point de dérivation batterie Battery connector point Batterie-Abzweigungspunkt Punto de conexiones de la batería	
25	Relay interruttore 30A Relais de coupure 30A 30A Switch Relay Relais-Schalter 30A Relé interruptor 30A	
26	Fusibile 7.5A / Fusible 7.5A / 7.5A Fuse Schmelzsicherung 7.5A / Fusible 7.5A	
27	Relay interruttore 30A Relais de coupure 30A 30A Switch Relay Relais-Schalter 30A Relé interruptor 30A	Comando giunto elettromagnetico compressore Commande l'embrayage électromagnétique du compresseur Compressor electromagnetic clutch control Steuerung der elektromagnetischen Kupplung des Kompressors Comando junta electromagnética compresor
28	Fusibile 7.5A / Fusible 7.5A / 7.5A Fuse Schmelzsicherung 7.5A / Fusible 7.5A	
29	Fusibile 40A Maxi Fusible 40A Maxi 40A Maxi Fuse Schmelzsicherung 40A Maxi Fusible 40A Maxi	
30	Relay interruttore 30A Relais de coupure 30A 30A Switch Relay Relais-Schalter 30A Relé interruptor 30A	Comando elettroventola n.36 Commande l' électroventilateur n.36 Fan no.36 control Elektrolüfter Nr.36-Steuerung Comando electroventilador n.36
31	Fusibile 50A Maxi Fusible 50A Maxi 50A Maxi Fuse Schmelzsicherung 50 A Maxi Fusible 50A Maxi	
32	Relay interruttore 50A Relais de coupure 50A 50A Switch Relay Relais-Schalter 50A Relé interruptor 50A	Comando elettroventola n.37 Commande l' électroventilateur n.37 Fan no.37 control Elektrolüfter Nr.37-Steuerung Comando electroventilador n.37
33	Scatola porta fusibili-relays Boîte à fusibles-relais Fuses-relyas box Schmelzsicherung-Relaiskasten Caja porta-fusibles-realais	

34	<p>Centralina IE Dispositif de contrôle à injection électronique Electronic injection box unit Elektronisches Einspritzgehäuse Centralita IE</p> <p>VISTEON made in Spain S/N VY4CXIA00HZC VP6C1U - 14A638 - AD VP6C1U - 12B523 - AB DCU - 102</p>	(2.2 MJT - 2.2 HDi)
34A	<p>Connettore 32 vie Connecteur à 32 voies 32-way connector 32-weg-Steckverbinder Conector 32 vías</p>	(2.2 MJT - 2.2 HDi)
34B	<p>Connettore 48 vie Connecteur à 48 voies 48-way connector 48-weg-Steckverbinder Conector 48 vías</p>	(2.2 MJT - 2.2 HDi)
34C	<p>Connettore 32 vie Connecteur à 32 voies 32-way connector 32-weg-Steckverbinder Conector 32 vías</p>	(2.2 MJT - 2.2 HDi)
35	<p>Relay interruttore 30A Relais de coupure 30A 30A Switch Relay Relais-Schalter 30A Relé interruptor 30A</p>	
36	<p>Elettroventola Electroventilateur Fan Elektrolüfter Electroventilador</p>	<p>Raffreddamento radiatore e condensatore Refroidissement radiateur et condenseur Radiator and condenser cooling Kühler- und Kondensatorkühlung Enfriamiento radiador y condensador</p>
37	<p>Elettroventola Electroventilateur Fan Elektrolüfter Electroventilador</p>	<p>Raffreddamento radiatore e condensatore Refroidissement radiateur et condenseur Radiator and condenser cooling Kühler- und Kondensatorkühlung Enfriamiento radiador y condensador</p>
38	<p>Connettore 1 via Connecteur à 1 voie 1-way connector 1-weg-Steckverbinder Conector 1 vía</p>	
39	<p>Convogliatore Convoyeur d'air Air conveyor Luftforderer Canalizador de aire</p>	
40	<p>Punto di massa originale Point de masse d'origine Original ground point Original-Massepunkt Punto de masa original</p>	
41	<p>Connettore 1 via Connecteur à 1 voie 1-way connector 1-weg-Steckverbinder Conector 1 vía</p>	<p>Giunto elettromagnetico compressore Embrayage électromagnétique du compresseur Compressor electromagnetic clutch Elektromagnetische Kupplung des Kompressors Junta electromagnética del compresor</p>
42	<p>Connettore 5 vie Connecteur à 5 voies 5-way connector 5-weg-Steckverbinder Conector 5 vías</p>	
43	<p>Connettore 20 vie (nero) Connecteur à 20 voies (noir) 20-way connector (black) 20-weg-Steckverbinder (Schwarz) Conector 20 vía (negro)</p>	

44	Giunzione RAYCHEM ROSSO Raccord RAYCHEM ROUGE RED RAYCHEM connector RAYCHEM Verbindung ROT Junta RAYCHEM ROJO	
47	Logica funzionamento elettroventole Logique fonctionnement électroventilateurs Electric fan logic Betriebslogik der Elektrolüfter Logica funcionamiento electroventiladores	

(I)

N.B.:

Le parti in tratteggio rappresentano componenti dell'impianto elettrico originale.

(F)

N.B.:

Les parties hachurées représentent des composants du faisceau électrique d'origine.

(GB)

N.B.:

The dashed parts represent components of the original electric system.

(D)

N.B.:

Die gestrichelten Teile stellen Bauteile der ursprünglichen Anlage dar.

(E)

N.B.:

Les partes discontinuas representan componentes de la instalación eléctrica original.

ITALIANO	FRANCAIS	ENGLISH	DEUTSCH	ESPANOL
Arancio	Orange	Orange	Orange	Naranjado
Azzurro	D'azur	Light blue	Hellblau	Azul
Bianco	Blanc	White	Weiss	Blanco
Blu	Bleu	Blue	Blau	Turqui
Giallo	Jaune	Yellow	Gelb	Amarillo
Grigio	Gris	Gray	Grau	Gris
Marrone	Marron	Brown	Braun	Marron
Nero	Noir	Black	Schwarz	Negro
Rosa	Rose	Pink	Rosa	Rosa
Rosso	Rouge	Red	Rot	Rojo
Verde	Vert	Green	Grün	Verde
Viola	Violet	Violet	Violett	Violado

(I)
DELPHI ITALIA mira ad un costante miglioramento dei propri prodotti. La Casa si riserva il diritto di apportare in qualunque momento e senza preavviso modifiche ai modelli e ai componenti descritti in questa pubblicazione per ragioni di natura tecnica o commerciale. Per ulteriori informazioni rivolgersi al servizio assistenza DELPHI.

(F)
DELPHI ITALIA vise à une amélioration constante des ces produits. La maison se réserve le droit d'apporter, à tout moment et sans préavis, des modifications aux modèles et aux composants décrits dans cette publication pour des raisons d'ordre technique ou commerciale. Pour d'ultérieures informations s'adresser au service d'assistance DELPHI.

(GB)
DELPHI ITALIA focuses on constant upgrading of its products. The Manufacturer reserves the right to modify the models and components described in the present publication at any time for technical or commercial reasons and without prior notice. For further information, contact DELPHI technical services.

(D)
DELPHI ITALIA ist stets bestrebt die eigenen Produkte zu verbessern. Die Herstellerfirma behält sich das Recht vor, aus technischen oder Verkaufsgründen, zu jeder Zeit und ohne vorherige Ankündigung, Abänderungen an den Modellen und den in dieser Veröffentlichung beschriebenen Einbauteile vorzunehmen. Für weitere Informationen bitten wir Sie, sich an unseren DELPHI Kundendienst zu wenden.

(E)
DELPHI ITALIA aspira a un constante mejoramiento de su producción. La Fábrica se reserva el derecho de aportar en cualquier momento y sin preaviso modificaciones a los modelos y los componentes descritos en esta publicación por razones técnicas o comerciales. Para ultteriores informaciones dirigirse al servicio asistencia DELPHI.

VENDITA E SERVIZIO
VENTE ET SERVICE

VERKAUF UND SERVICE
SALE AND SERVICE

DELPHI ITALIA AUTOMOTIVE SYSTEMS S.r.l.
Stabilimento Molinella

Via Nobili, 2 40062 Molinella (Bologna)-Italy
Telefono (0039) 051.6906111

Fax (0039) 051.6906287

Email: diavia.service@delphi.com

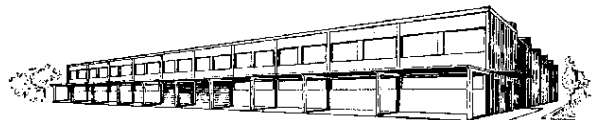

MOD. SCHFI389

II / '09
(2008)

Questa pubblicazione è stata curata da DELPHI ITALIA-Diavia
Ufficio Fitting Instructions - Stabilimento Molinella

This publication has been edited by DELPHI ITALIA-Diavia
Fitting Instructions Office - Factory Molinella